



RF LDMOS Wideband Integrated Power Amplifiers

The MW6IC2015N wideband integrated circuit is designed for base station applications. It uses Freescale's newest High Voltage (26 to 32 Volts) LDMOS IC technology and integrates a multi-stage structure. Its wideband on-chip design makes it usable from 1805 to 1990 MHz. The linearity performances cover all modulation formats for cellular applications: GSM, GSM EDGE, PHS, TDMA, CDMA, W-CDMA and TD-SCDMA.

Final Application

- Typical Two-Tone Performance: $V_{DD} = 26$ Volts, $I_{DQ1} = 100$ mA, $I_{DQ2} = 170$ mA, $P_{out} = 15$ Watts PEP, $f = 1930$ MHz
 Power Gain — 26 dB
 Power Added Efficiency — 28%
 IMD — -30 dBc

Driver Application

- Typical GSM EDGE Performance: $V_{DD} = 26$ Volts, $I_{DQ1} = 130$ mA, $I_{DQ2} = 170$ mA, $P_{out} = 3$ Watts Avg., Full Frequency Band (1805-1880 MHz or 1930-1990 MHz)
 Power Gain — 27 dB
 Power Added Efficiency — 19%
 Spectral Regrowth @ 400 kHz Offset = -69 dBc
 Spectral Regrowth @ 600 kHz Offset = -78 dBc
 EVM — 0.8% rms
- Capable of Handling 3:1 VSWR, @ 26 Vdc, 1990 MHz, 15 Watts CW Output Power
- Stable into a 3:1 VSWR. All Spurs Below -60 dBc @ 100 mW to 8 W CW P_{out} .

Features

- Characterized with Series Equivalent Large-Signal Impedance Parameters and Common Source Scattering Parameters
- On-Chip Matching (50 Ohm Input, DC Blocked, >5 Ohm Output)
- Integrated Quiescent Current Temperature Compensation with Enable/Disable Function (1)
- Integrated ESD Protection
- Designed for Lower Memory Effects and Wide Instantaneous Bandwidth Applications
- 225°C Capable Plastic Package
- RoHS Compliant
- In Tape and Reel. R1 Suffix = 500 Units per 44 mm, 13 inch Reel

MW6IC2015NBR1
MW6IC2015GNBR1

1805-1990 MHz, 15 W, 26 V
GSM/GSM EDGE, CDMA
RF LDMOS WIDEBAND
INTEGRATED POWER AMPLIFIERS

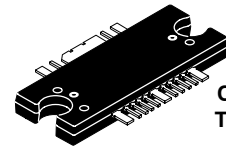

CASE 1329-09
TO-272 WB-16
PLASTIC
MW6IC2015NBR1

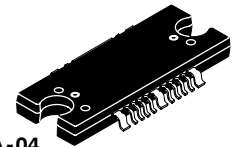

CASE 1329A-04
TO-272 WB-16 GULL
PLASTIC
MW6IC2015GNBR1

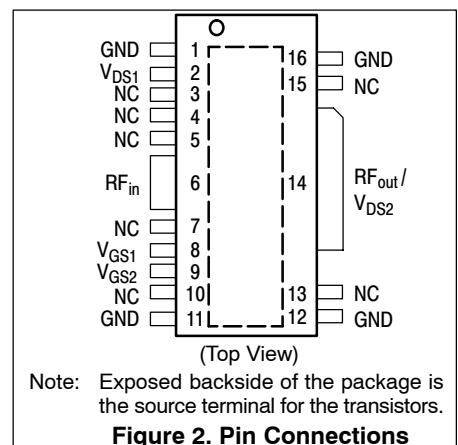
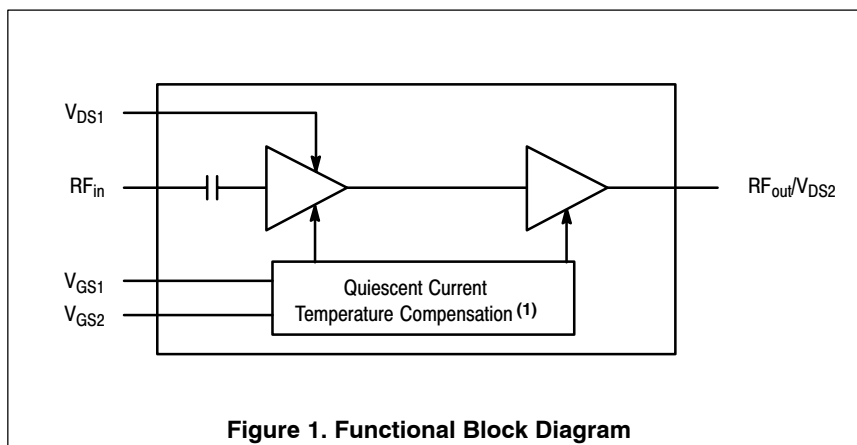

1. Refer to AN1977, *Quiescent Current Thermal Tracking Circuit in the RF Integrated Circuit Family* and to AN1987, *Quiescent Current Control for the RF Integrated Circuit Device Family*. Go to <http://www.freescale.com/rf>. Select Documentation/Application Notes - AN1977 or AN1987.

Table 1. Maximum Ratings

Rating	Symbol	Value	Unit
Drain-Source Voltage	V_{DSS}	-0.5, +68	Vdc
Gate-Source Voltage	V_{GS}	-0.5, +6	Vdc
Storage Temperature Range	T_{stg}	-65 to +150	°C
Case Operating Temperature	T_C	150	°C
Operating Junction Temperature (1,2)	T_J	225	°C
Input Power	P_{in}	20	dBm

Table 2. Thermal Characteristics

Characteristic	Symbol	Value (2,3)	Unit
Thermal Resistance, Junction to Case	$R_{\theta JC}$		°C/W
Final Application ($P_{out} = 15$ W CW)	Stage 1, 26 Vdc, $I_{DQ1} = 100$ mA Stage 2, 26 Vdc, $I_{DQ2} = 170$ mA	4.3 1.2	
Driver Application ($P_{out} = 3$ W CW)	Stage 1, 26 Vdc, $I_{DQ1} = 130$ mA Stage 2, 26 Vdc, $I_{DQ2} = 170$ mA	4.3 1.3	

Table 3. ESD Protection Characteristics

Test Methodology	Class
Human Body Model (per JESD22-A114)	1A (Minimum)
Machine Model (per EIA/JESD22-A115)	A (Minimum)
Charge Device Model (per JESD22-C101)	III (Minimum)

Table 4. Moisture Sensitivity Level

Test Methodology	Rating	Package Peak Temperature	Unit
Per JESD 22-A113, IPC/JEDEC J-STD-020	3	260	°C

Table 5. Electrical Characteristics ($T_C = 25^\circ\text{C}$ unless otherwise noted)

Characteristic	Symbol	Min	Typ	Max	Unit
----------------	--------	-----	-----	-----	------

Functional Tests (In Freescale 1930-1990 MHz Test Fixture, 50 ohm system) $V_{DD} = 26$ Vdc, $I_{DQ1} = 100$ mA, $I_{DQ2} = 170$ mA, $P_{out} = 15$ W PEP, $f_1 = 1930$ MHz, $f_2 = 1930.1$ MHz, Two-Tone CW

Power Gain	G_{ps}	24	26	—	dB
Power Added Efficiency	PAE	26	28	—	%
Intermodulation Distortion	IMD	—	-30	-27	dBc
Input Return Loss	IRL	—	—	-10	dB

Typical Two-Tone Performances (In Freescale Test Fixture, 50 ohm system) $V_{DD} = 26$ Vdc, $I_{DQ1} = 100$ mA, $I_{DQ2} = 170$ mA, $P_{out} = 15$ W PEP, 1805-1880 MHz, Two-Tone CW, 100 kHz Tone Spacing

Power Gain	G_{ps}	—	26	—	dB
Power Added Efficiency	PAE	—	28	—	%
Intermodulation Distortion	IMD	—	-30	—	dBc
Input Return Loss	IRL	—	-10	—	dB

1. Continuous use at maximum temperature will affect MTTF.
2. MTTF calculator available at <http://www.freescale.com/rf>. Select Software & Tools/Development Tools/Calculators to access MTTF calculators by product.
3. Refer to AN1955, *Thermal Measurement Methodology of RF Power Amplifiers*. Go to <http://www.freescale.com/rf>. Select Documentation/Application Notes - AN1955.

(continued)

Table 5. Electrical Characteristics ($T_C = 25^\circ\text{C}$ unless otherwise noted) (continued)

Characteristic	Symbol	Min	Typ	Max	Unit
Typical Performances (In Freescale Test Fixture, 50 ohm system) $V_{DD} = 26\text{ Vdc}$, $I_{DQ1} = 100\text{ mA}$, $I_{DQ2} = 170\text{ mA}$, 1805-1880 MHz and 1930-1990 MHz					
Saturated Pulsed Output Power, CW (8 μsec (on), 1 msec (off))	P_{sat}	—	35	—	W
Quiescent Current Accuracy over Temperature with 1.8 k Ω Gate Feed Resistors (-10 to 85 $^\circ\text{C}$) (1)	ΔI_{Q_T}	—	± 3	—	%
Gain Flatness in 30 MHz Bandwidth @ $P_{\text{out}} = 3\text{ W CW}$	G_F	—	0.3	—	dB
Average Deviation from Linear Phase in 30 MHz Bandwidth @ $P_{\text{out}} = 3\text{ W CW}$	Φ	—	± 1	—	$^\circ$
Average Group Delay @ $P_{\text{out}} = 3\text{ W CW}$ Including Output Matching	Delay	—	2.7	—	ns
Part-to-Part Insertion Phase Variation @ $P_{\text{out}} = 3\text{ W CW}$, Six Sigma Window	$\Delta\Phi$	—	± 15	—	$^\circ$

Typical GSM EDGE Performances (In Freescale GSM EDGE Test Fixture, 50 ohm system) $V_{DD} = 26\text{ Vdc}$, $I_{DQ1} = 130\text{ mA}$, $I_{DQ2} = 170\text{ mA}$, $P_{\text{out}} = 3\text{ W Avg.}$, 1805-1990 MHz and 1930-1990 MHz EDGE Modulation

Power Gain	G_{ps}	—	27	—	dB
Power Added Efficiency	PAE	—	19	—	%
Error Vector Magnitude	EVM	—	0.8	—	%
Spectral Regrowth at 400 kHz Offset	SR1	—	-69	—	dBc
Spectral Regrowth at 600 kHz Offset	SR2	—	-78	—	dBc

1. Refer to AN1977, *Quiescent Current Thermal Tracking Circuit in the RF Integrated Circuit Family* and to AN1987, *Quiescent Current Control for the RF Integrated Circuit Device Family*. Go to <http://www.freescale.com/rf>. Select Documentation/Application Notes - AN1977 or AN1987.

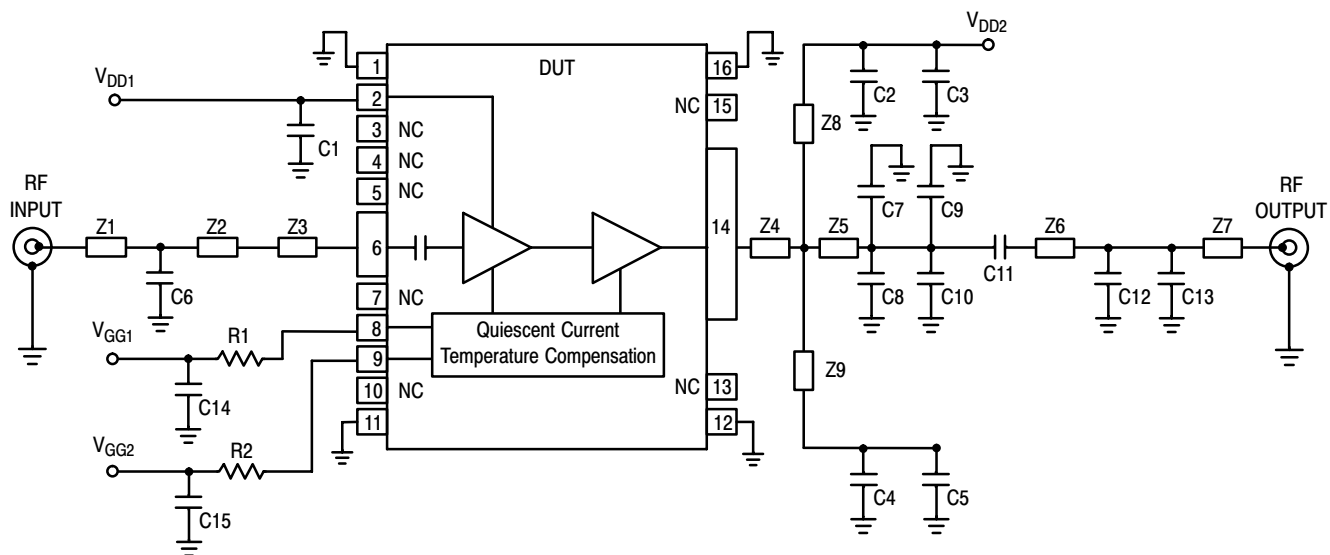

- | | | | |
|-----|--------------------------|--------|--|
| Z1* | 1.68" x 0.08" Microstrip | Z6* | 0.61" x 0.04" Microstrip |
| Z2 | 0.50" x 0.08" Microstrip | Z7 | 1.30" x 0.04" Microstrip |
| Z3 | 0.15" x 0.04" Microstrip | Z8, Z9 | 1.18" x 0.08" Microstrip |
| Z4 | 0.13" x 0.35" Microstrip | PCB | Taconic TLX8-0300, 0.030", $\epsilon_r = 2.55$ |
| Z5 | 0.10" x 0.35" Microstrip | | |
- * Variable for tuning.

Figure 3. MW6IC2015NBR1(GNBR1) Test Circuit Schematic — 1930-1990 MHz

Table 6. MW6IC2015NBR1(GNBR1) Test Circuit Component Designations and Values — 1930-1990 MHz

Part	Description	Part Number	Manufacturer
C1, C14, C15	2.2 μ F Chip Capacitors	C3225X5R1H225MT	TDK
C2, C4, C11	5.6 pF Chip Capacitors	ATC100B5R6CT500XT	ATC
C3, C5	10 μ F Chip Capacitors	C5750X5R1H106MT	TDK
C6	1 pF Chip Capacitor	ATC100B1R0BT500XT	ATC
C7, C8	2.2 pF Chip Capacitors	ATC100B2R2BT500XT	ATC
C9, C10	0.5 pF Chip Capacitors	ATC100B0R5BT500XT	ATC
C12	0.2 pF Chip Capacitor	ATC100B0R2BT500XT	ATC
C13	0.1 pF Chip Capacitor	ATC100B0R1BT500XT	ATC
R1	10 k Ω , 1/4 W Chip Resistor	CRCW12061002FKEA	Vishay
R2	18 Ω , 1/4 W Chip Resistor	CRCW120618R0FKEA	Vishay

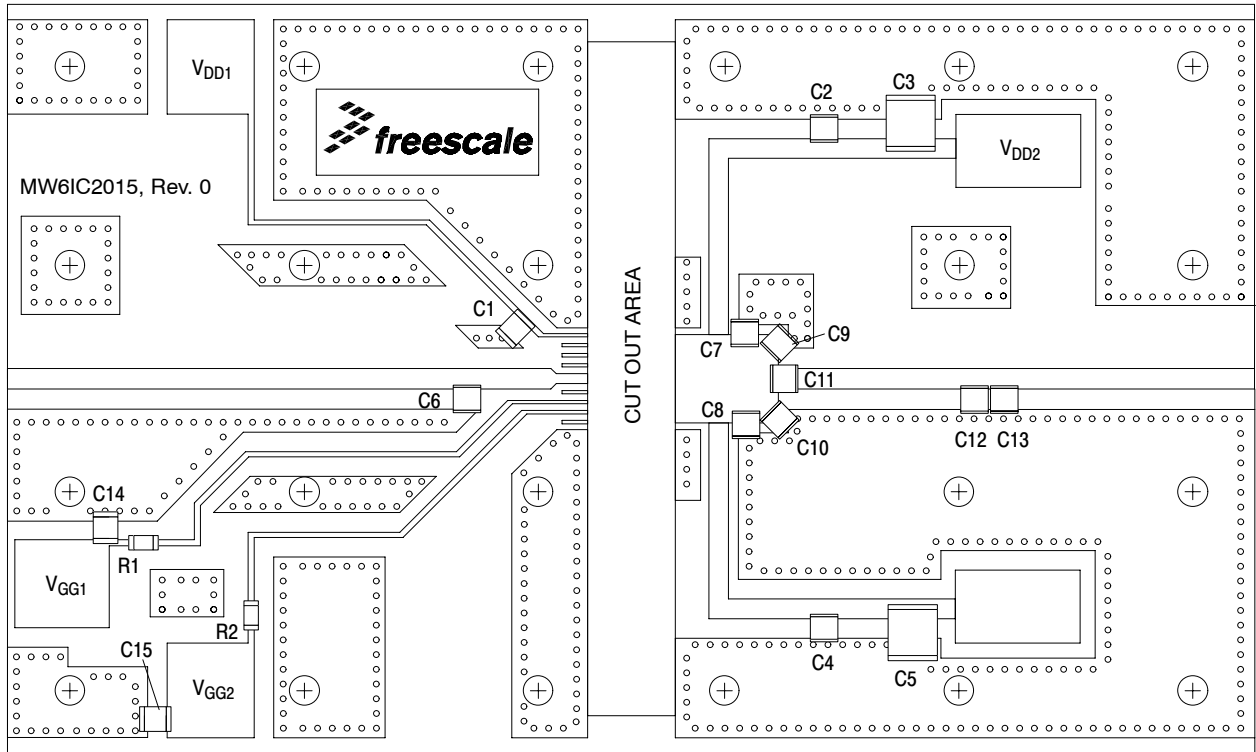

Figure 4. MW6IC2015NBR1(GNBR1) Test Circuit Component Layout — 1930-1990 MHz

TYPICAL CHARACTERISTICS — 1930-1990 MHz

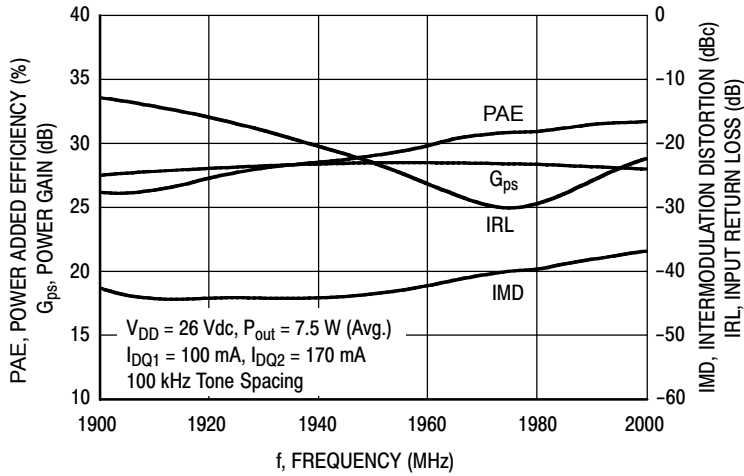

Figure 5. Two-Tone Wideband Performance @ $P_{out} = 7.5$ Watts Avg.

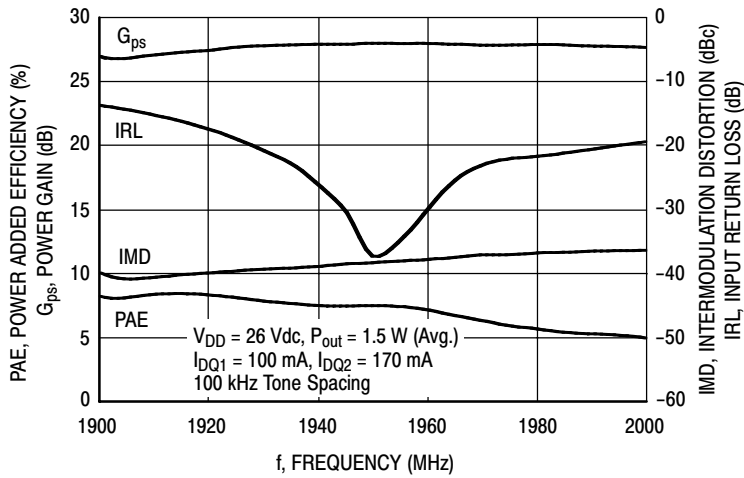

Figure 6. Two-Tone Wideband Performance @ $P_{out} = 1.5$ Watts Avg.

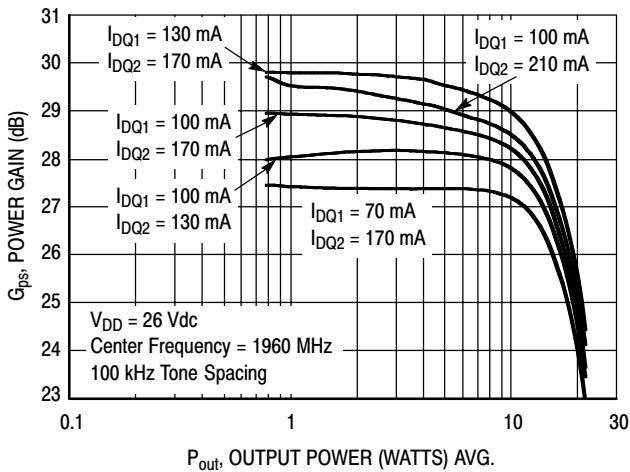

Figure 7. Two-Tone Power Gain versus Output Power

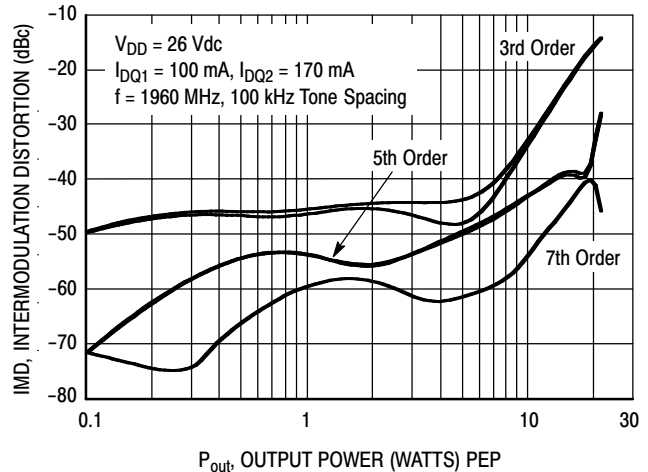

Figure 8. Intermodulation Distortion Products versus Output Power

TYPICAL CHARACTERISTICS — 1930-1990 MHz

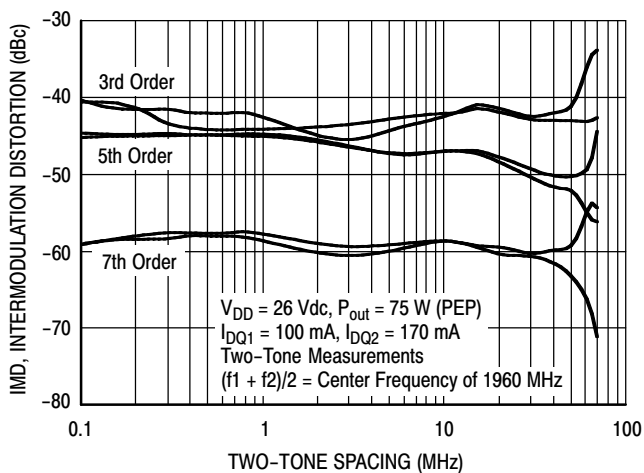

Figure 9. Intermodulation Distortion Products versus Tone Spacing

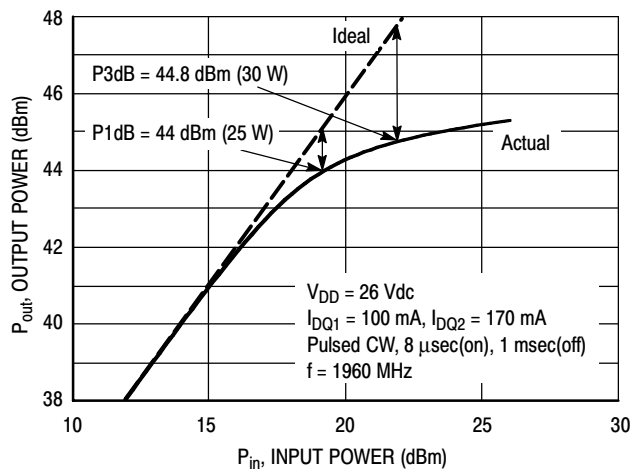

Figure 10. Pulsed CW Output Power versus Input Power

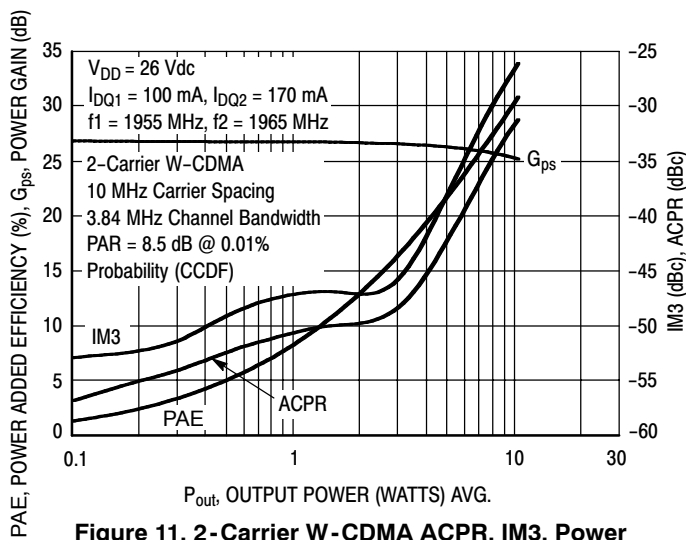

Figure 11. 2-Carrier W-CDMA ACPR, IM3, Power Gain and Power Added Efficiency versus Output Power

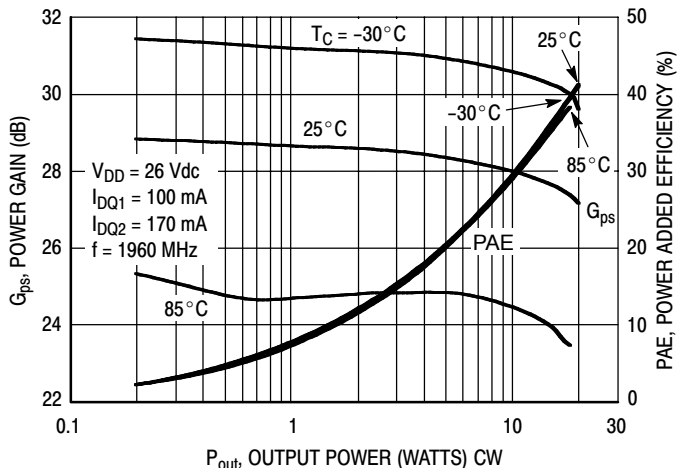

Figure 12. Power Gain and Power Added Efficiency versus CW Output Power

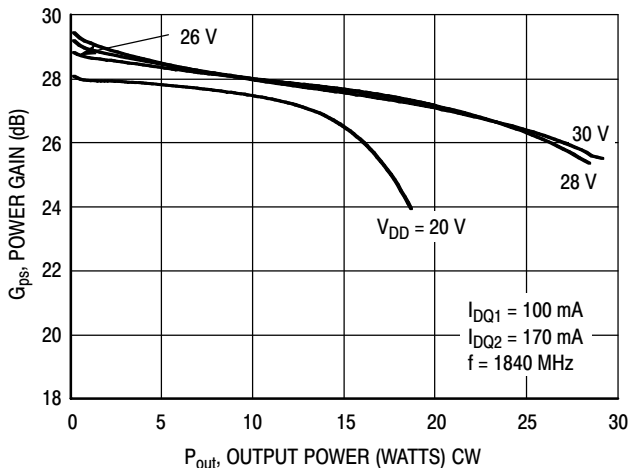

Figure 13. Power Gain versus Output Power

TYPICAL CHARACTERISTICS — 1930-1990 MHz

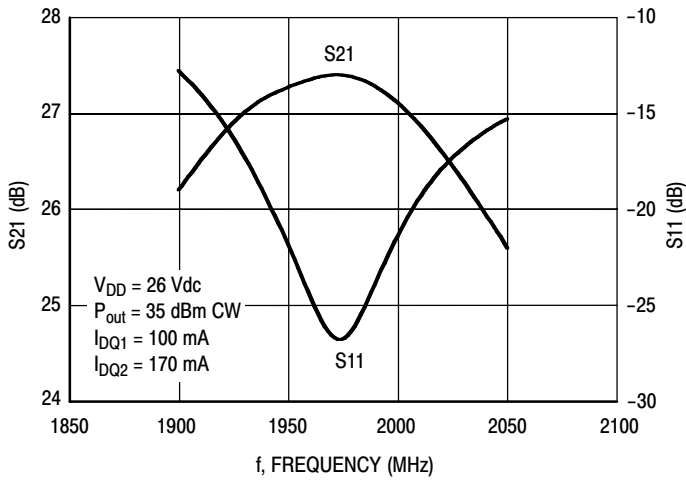

Figure 14. Broadband Frequency Response

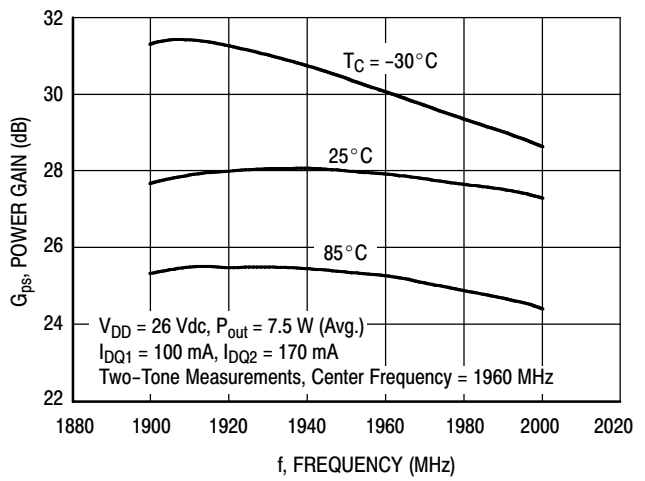

Figure 15. Power Gain versus Frequency

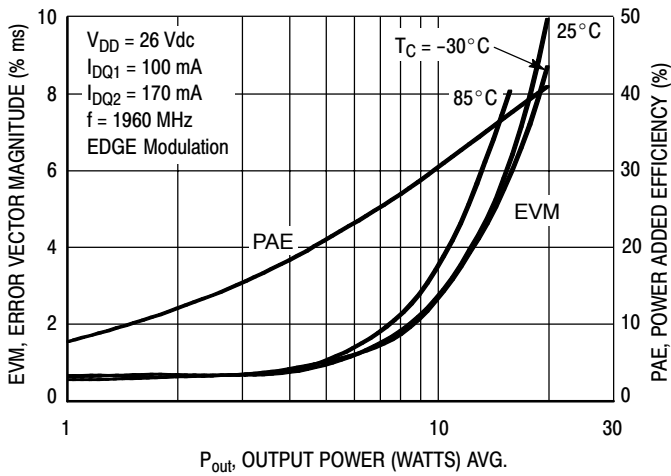

Figure 16. EVM and Power Added Efficiency versus Output Power

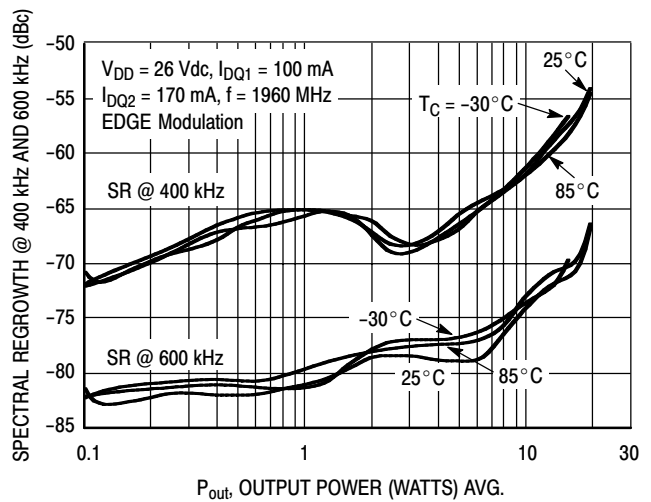
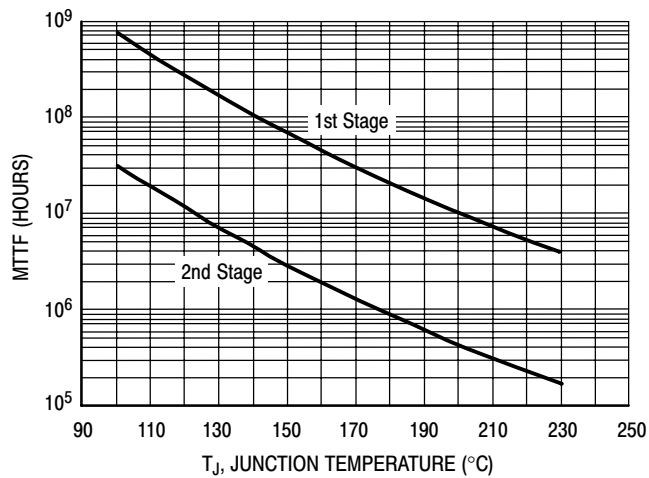

Figure 17. Spectral Regrowth at 400 and 600 kHz versus Output Power

TYPICAL CHARACTERISTICS



This above graph displays calculated MTTF in hours when the device is operated at $V_{DD} = 26$ Vdc, $P_{out} = 15$ W PEP, and PAE = 28%.

MTTF calculator available at <http://www.freescale.com/rf>. Select Software & Tools/Development Tools/Calculators to access MTTF calculators by product.

Figure 18. MTTF versus Junction Temperature

GSM TEST SIGNAL

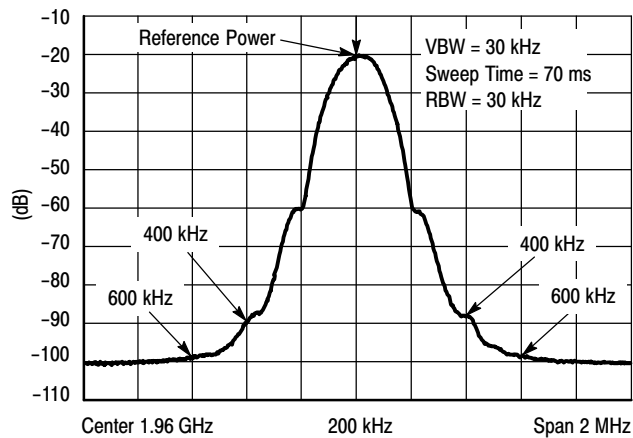
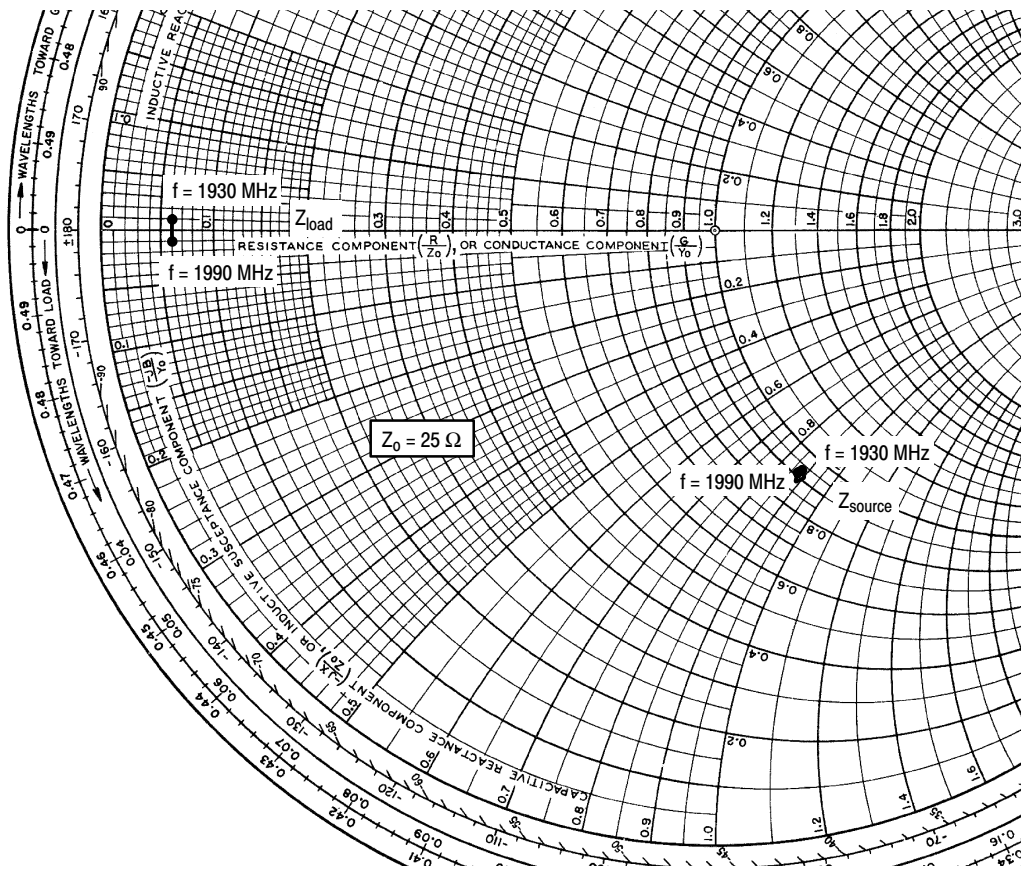

Figure 19. EDGE Spectrum



$V_{DD} = 26 \text{ Vdc}$, $I_{DQ1} = 100 \text{ mA}$, $I_{DQ2} = 170 \text{ mA}$, $P_{out} = 15 \text{ W CW}$

f MHz	Z_{source} Ω	Z_{load} Ω
1930	$23.37 - j21.93$	$1.62 + j0.26$
1950	$22.77 - j22.53$	$1.59 + j0.04$
1970	$22.19 - j22.20$	$1.57 - j0.16$
1990	$22.64 - j21.84$	$1.54 - j0.36$

Z_{source} = Test circuit impedance as measured from gate to ground.

Z_{load} = Test circuit impedance as measured from drain to ground.

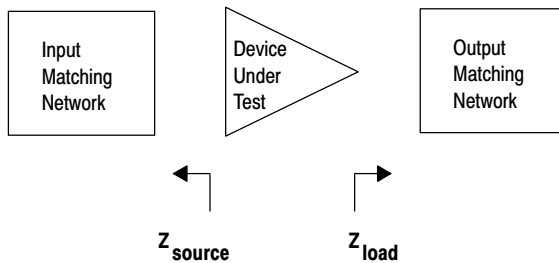
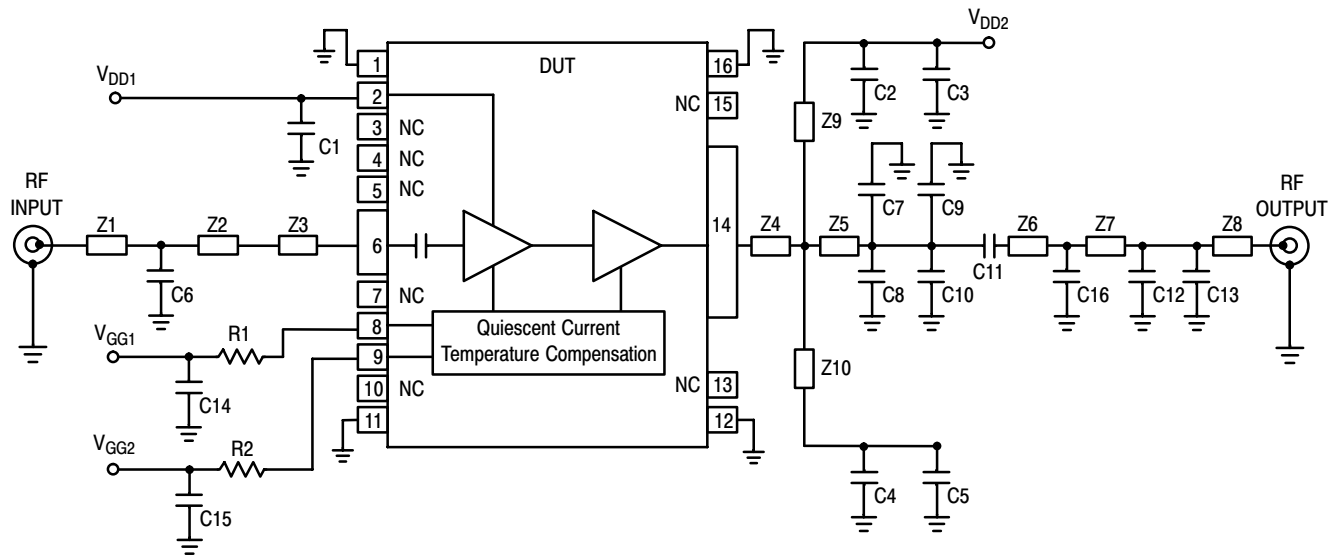

Figure 20. Series Equivalent Source and Load Impedance — 1930-1990 MHz



Z1*	1.64" x 0.08" Microstrip	Z7*	0.41" x 0.04" Microstrip
Z2	0.54" x 0.08" Microstrip	Z8	1.18" x 0.04" Microstrip
Z3	0.15" x 0.04" Microstrip	Z9, Z10	1.18" x 0.08" Microstrip
Z4	0.13" x 0.35" Microstrip	PCB	Taconic TLX8-0300, 0.030", $\epsilon_r = 2.55$
Z5	0.10" x 0.35" Microstrip		
Z6*	0.26" x 0.04" Microstrip		

* Variable for tuning.

Figure 21. MW6IC2015NBR1 (GNBR1) Test Circuit Schematic — 1805-1880 MHz

Table 7. MW6IC2015NBR1 (GNBR1) Test Circuit Component Designations and Values — 1805-1880 MHz

Part	Description	Part Number	Manufacturer
C1, C14, C15	2.2 μ F Chip Capacitors	C3225X5R1H225MT	TDK
C2, C4, C11	5.6 pF Chip Capacitors	ATC100B5R6CT500XT	ATC
C3, C5	10 μ F Chip Capacitors	C5750X5R1H106MT	TDK
C6	1.5 pF Chip Capacitor	ATC100A1R5BT500XT	ATC
C7, C8	2.7 pF Chip Capacitors	ATC100B2R7BT500XT	ATC
C9, C10, C12	0.8 pF Chip Capacitors	ATC100B0R8BT500XT	ATC
C13	0.1 pF Chip Capacitor	ATC100B0R1BT500XT	ATC
C16	1 pF Chip Capacitor	ATC100B1R0BT500XT	ATC
R1	10 k Ω , 1/4 W Chip Resistor	CRCW12061002FKEA	Vishay
R2	18 Ω , 1/4 W Chip Resistor	CRCW120618R0FKEA	Vishay

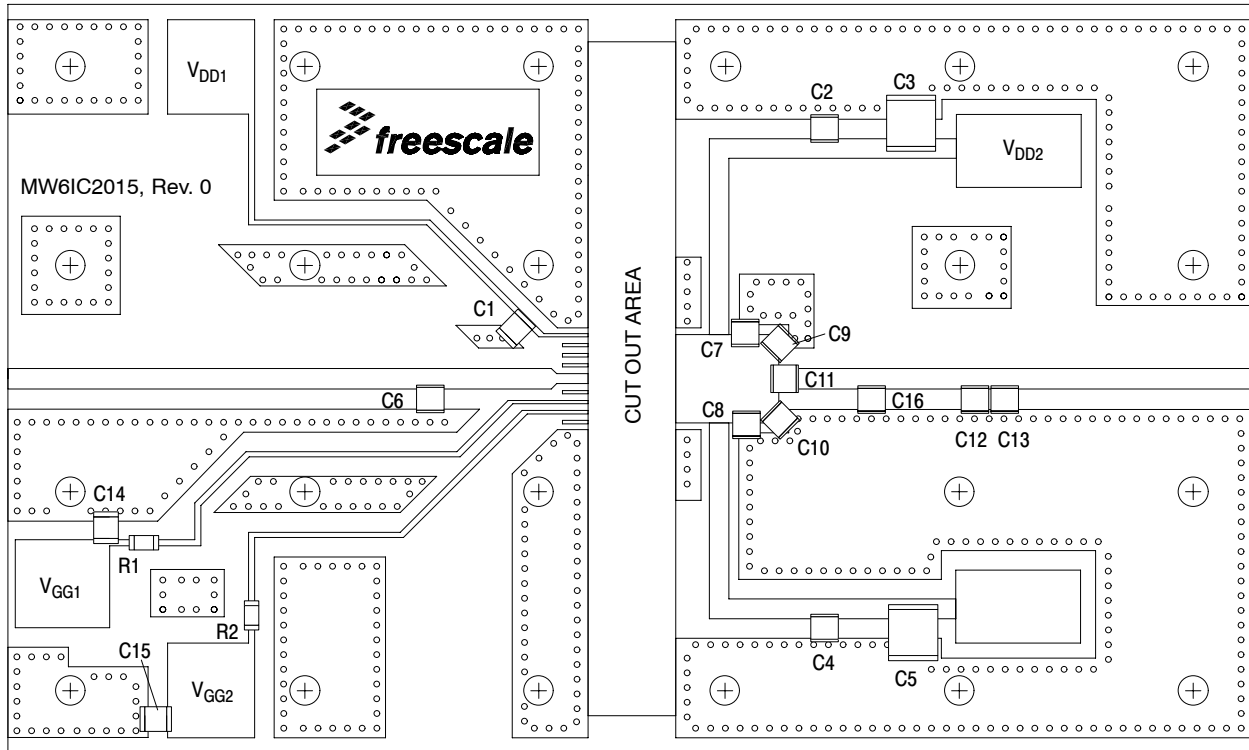

Figure 22. MW6IC2015NBR1(GNBR1) Test Circuit Component Layout — 1805-1880 MHz

TYPICAL CHARACTERISTICS — 1805-1880 MHz

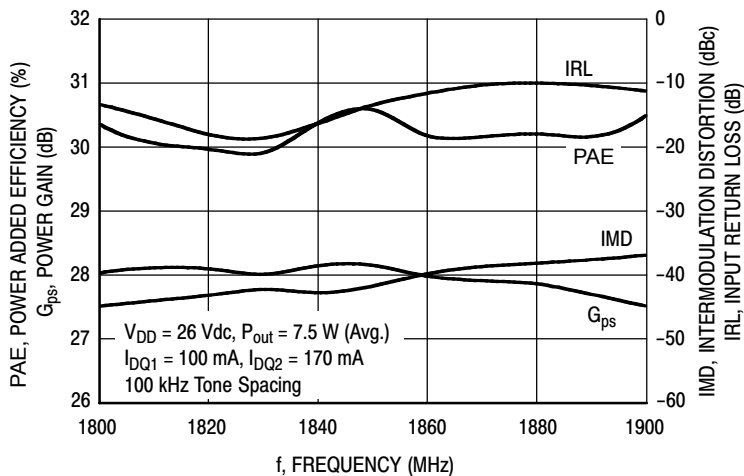

Figure 23. Two-Tone Wideband Performance @ $P_{out} = 7.5$ Watts Avg.

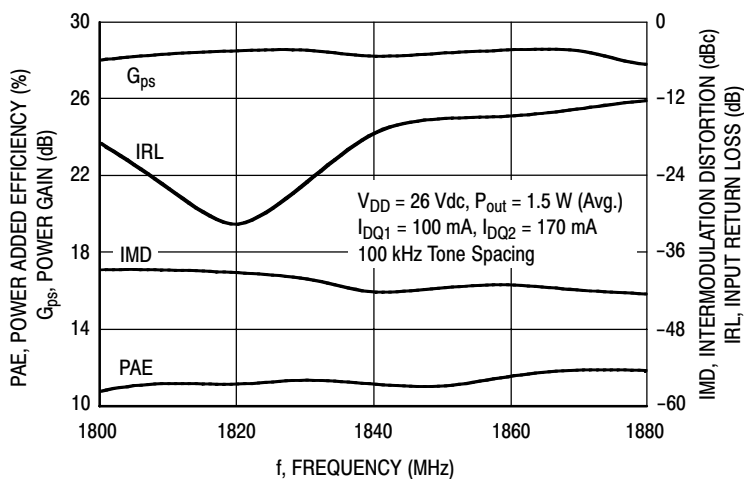

Figure 24. Two-Tone Wideband Performance @ $P_{out} = 1.5$ Watts Avg.

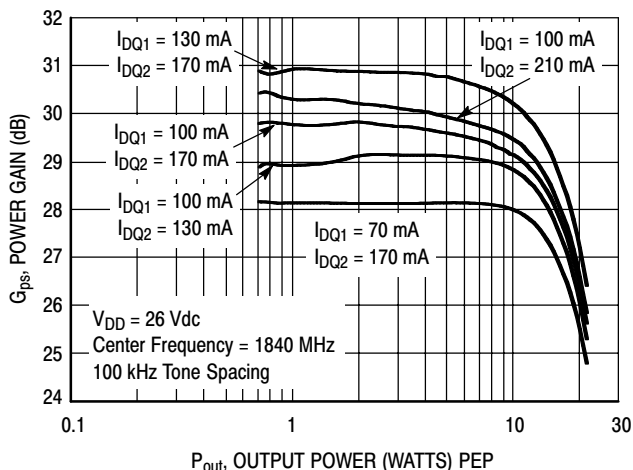

Figure 25. Two-Tone Power Gain versus Output Power

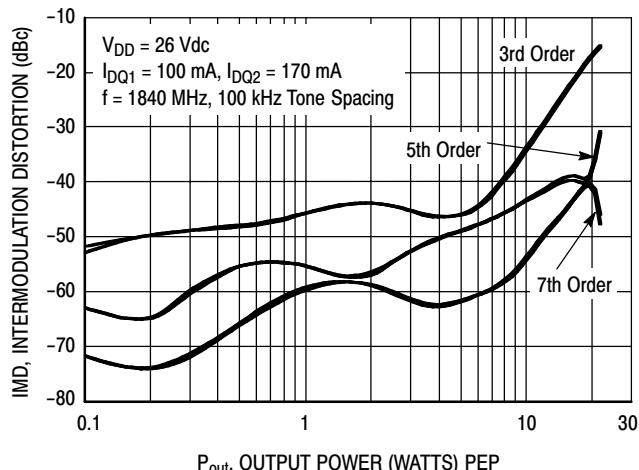

Figure 26. Intermodulation Distortion Products versus Output Power

TYPICAL CHARACTERISTICS — 1805-1880 MHz

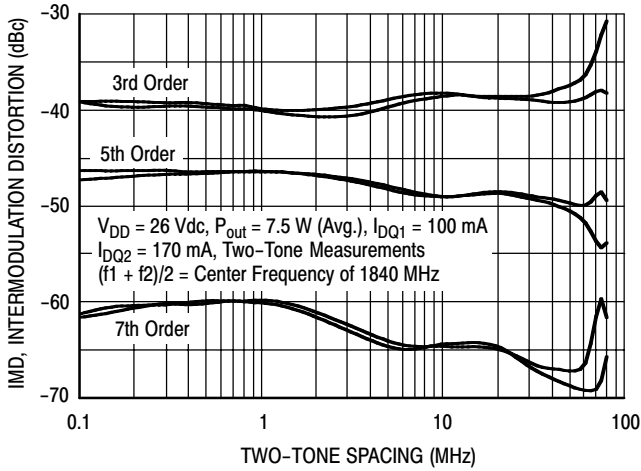

Figure 27. Intermodulation Distortion Products versus Tone Spacing

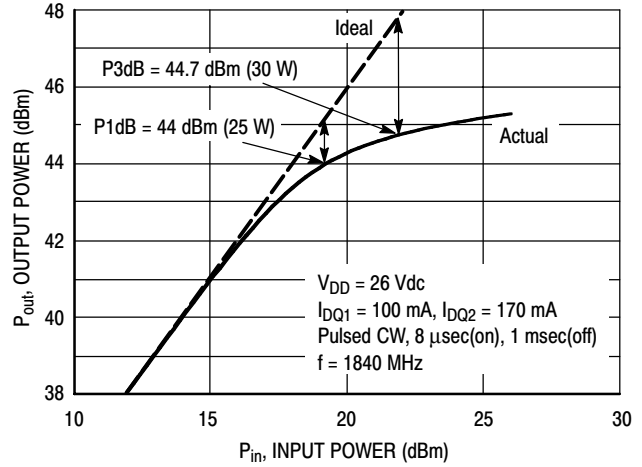

Figure 28. Pulsed CW Output Power versus Input Power

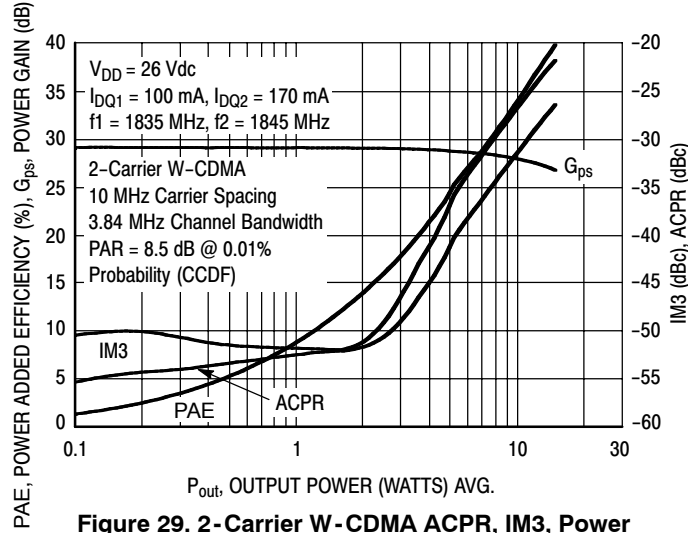

Figure 29. 2-Carrier W-CDMA ACPR, IM3, Power Gain and Power Added Efficiency versus Output Power

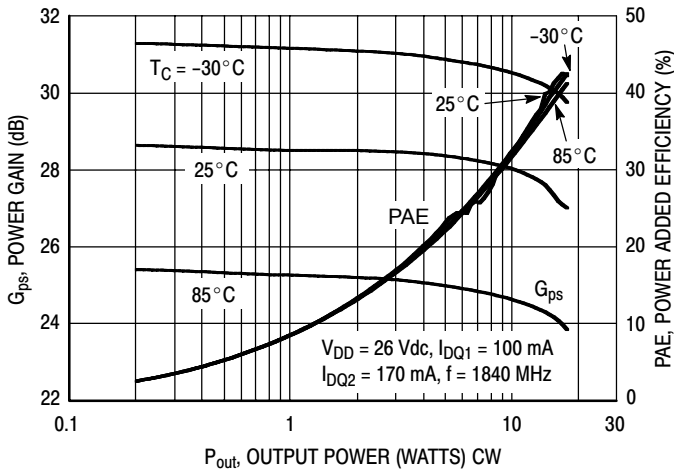

Figure 30. Power Gain and Power Added Efficiency versus CW Output Power

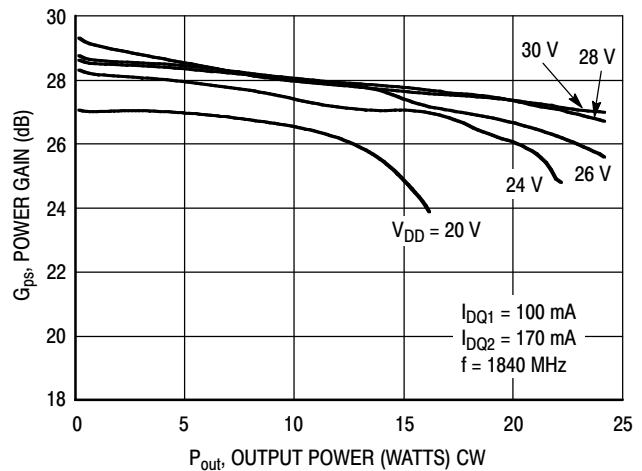

Figure 31. Power Gain versus Output Power

TYPICAL CHARACTERISTICS — 1805-1880 MHz

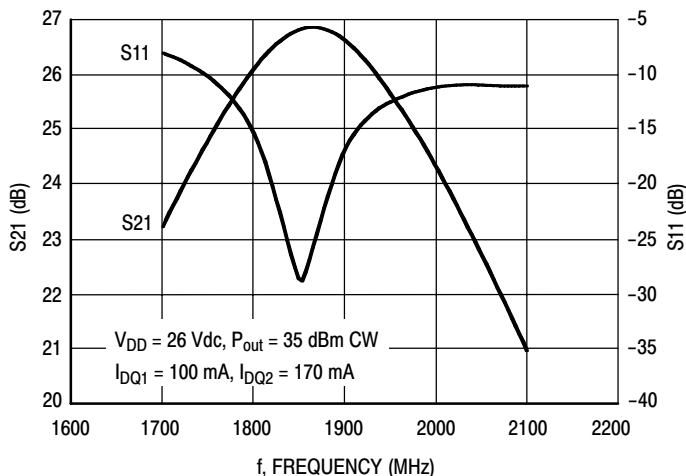

Figure 32. Broadband Frequency Response

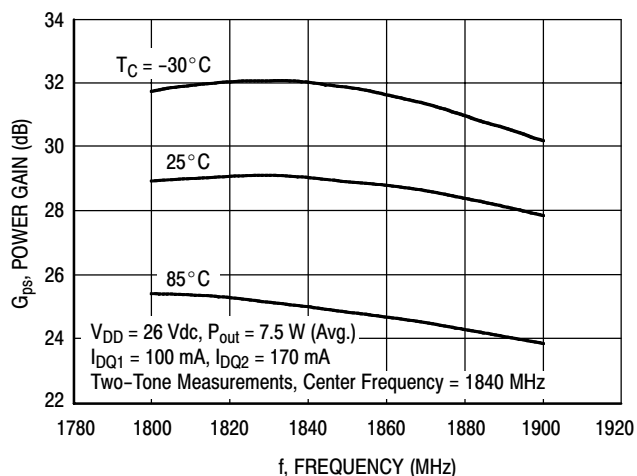

Figure 33. Power Gain versus Frequency

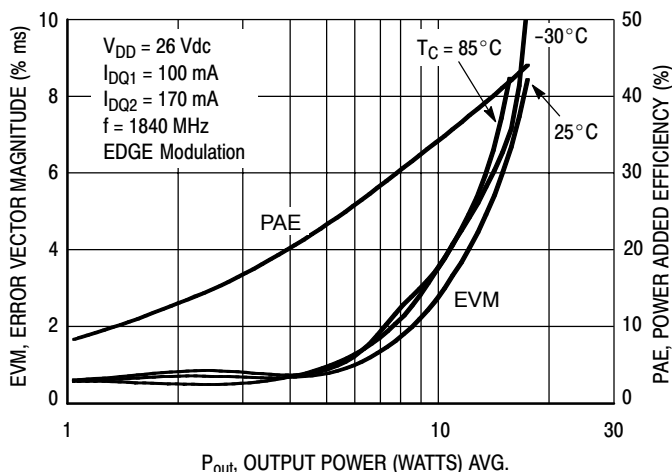

Figure 34. EVM and Power Added Efficiency versus Output Power

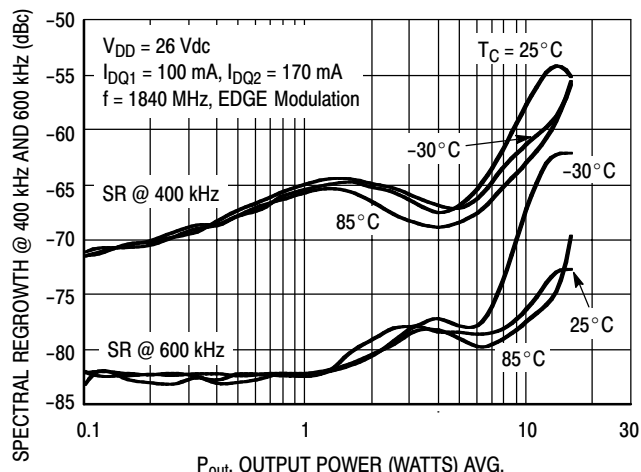
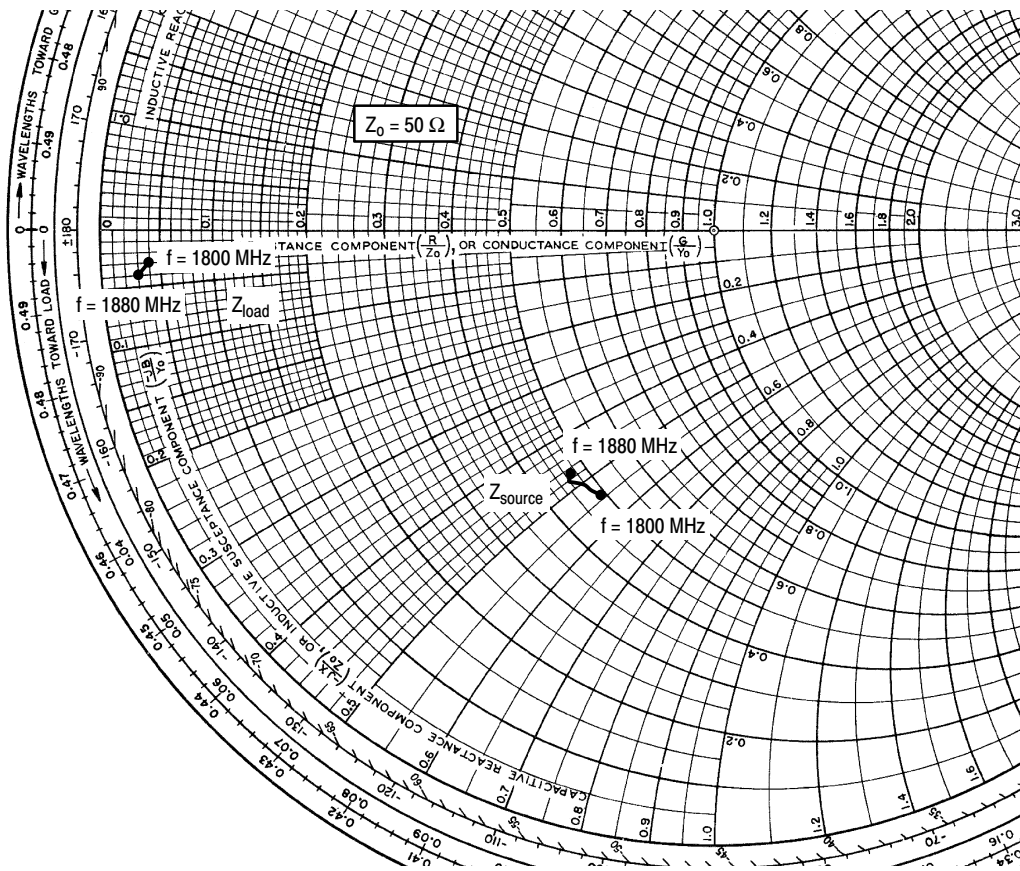

Figure 35. Spectral Regrowth at 400 and 600 kHz versus Output Power



$V_{DD} = 26 \text{ Vdc}$, $I_{DQ1} = 130 \text{ mA}$, $I_{DQ2} = 170 \text{ mA}$, $P_{out} = 3 \text{ W Avg.}$

f MHz	Z_{source} Ω	Z_{load} Ω
1800	24.32 - j26.99	1.94 - j1.29
1820	23.96 - j25.93	1.88 - j1.42
1840	23.86 - j25.63	1.83 - j1.54
1860	23.01 - j24.23	1.79 - j1.64
1880	23.55 - j23.33	1.74 - j1.75

Z_{source} = Test circuit impedance as measured from gate to ground.

Z_{load} = Test circuit impedance as measured from drain to ground.

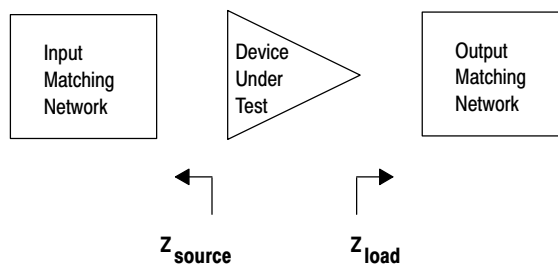
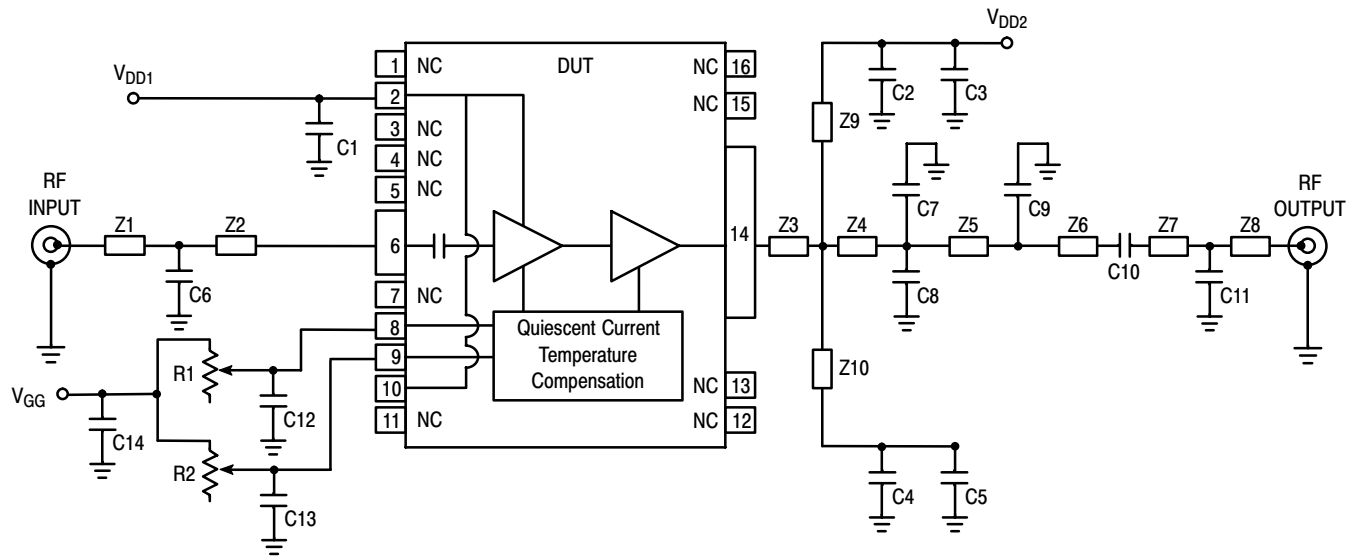

Figure 36. Series Equivalent Source and Load Impedance — 1805-1880 MHz

TD-SCDMA CHARACTERIZATION



Z1	0.772" x 0.056" Microstrip	Z6	0.060" x 0.237" Microstrip
Z2	0.409" x 0.056" Microstrip	Z7	0.539" x 0.056" Microstrip
Z3	0.138" x 0.237" Microstrip	Z8	0.190" x 0.056" Microstrip
Z4	0.148" x 0.237" Microstrip	Z9, Z10	1.066" x 0.078" Microstrip
Z5	0.064" x 0.237" Microstrip	PCB	Taconic TLX8, 0.020", $\epsilon_r = 2.55$

Figure 37. MW6IC2015NBR1(GNBR1) Test Circuit Schematic — TD-SCDMA

Table 8. MW6IC2015NBR1(GNBR1) Test Circuit Component Designations and Values — TD-SCDMA

Part	Description	Part Number	Manufacturer
C1, C3, C5, C14	2.2 μ F Chip Capacitors	C3225X5R1H225MT	TDK
C2, C4, C10	5.6 pF Chip Capacitors	08051J5R6CBS	AVX
C6	1 pF Chip Capacitor	08051J1R0BBS	AVX
C7, C8	2.7 pF Chip Capacitors	08051J2R7CBS	AVX
C9, C11	0.5 pF Chip Capacitors	08051J0R5BBS	AVX
C12, C13	100 nF Chip Capacitors	C1206CK104K5RC	Kemet
R1, R2	5 k Ω Potentiometer CMS Cermet Multi-turn	3224W	Bourns

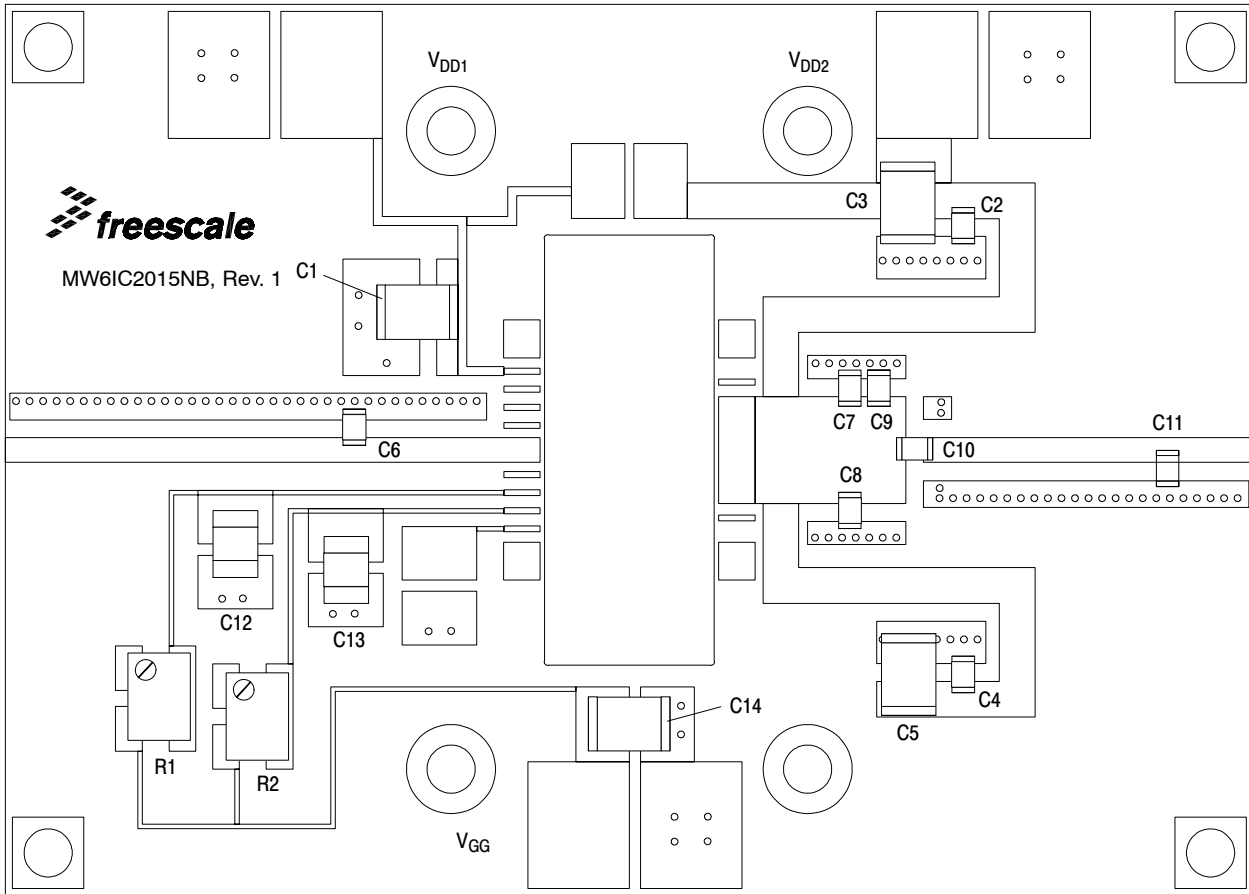

Figure 38. MW6IC2015NBR1(GNBR1) Test Circuit Component Layout — TD-SCDMA

TYPICAL CHARACTERISTICS

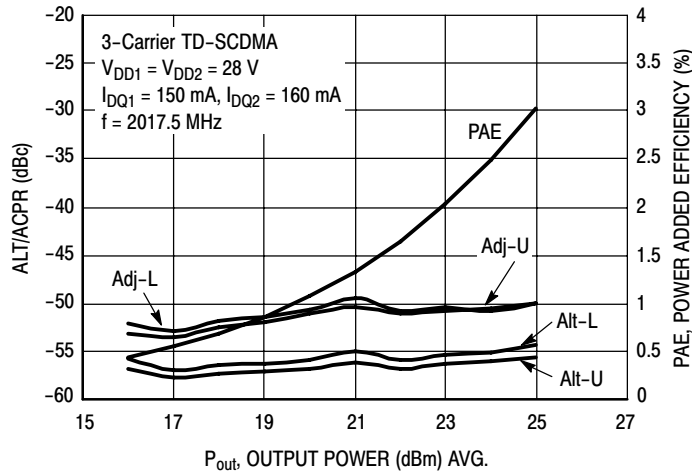

Figure 39. 3-Carrier TD-SCDMA ACPR, ALT and Power Added Efficiency versus Output Power

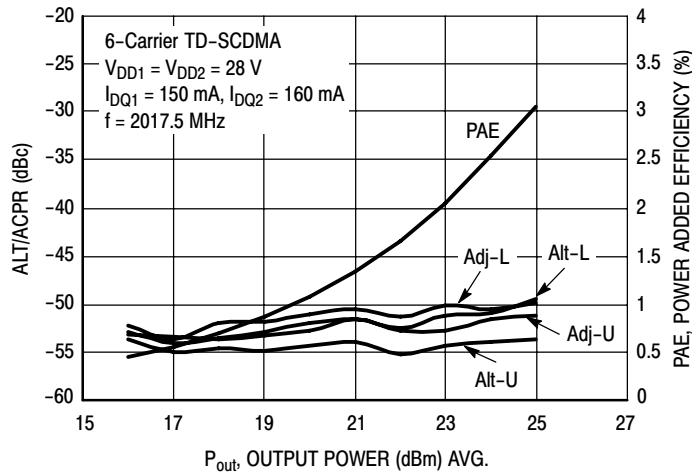

Figure 40. 6-Carrier TD-SCDMA ACPR, ALT and Power Added Efficiency versus Output Power

TD-SCDMA TEST SIGNAL

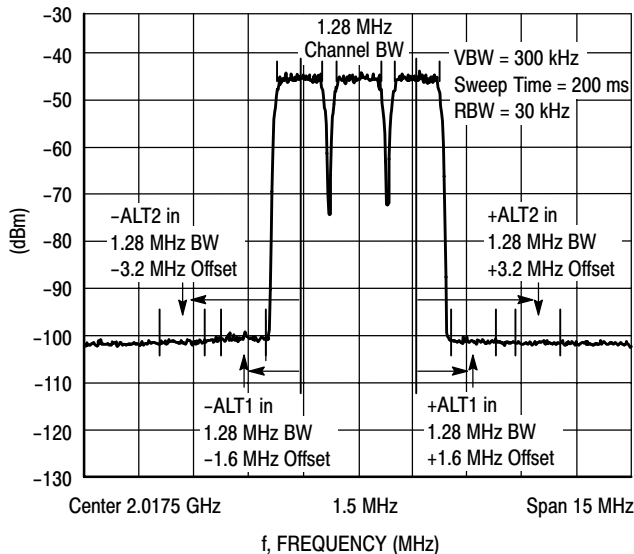

Figure 41. 3-Carrier TD-SCDMA Spectrum

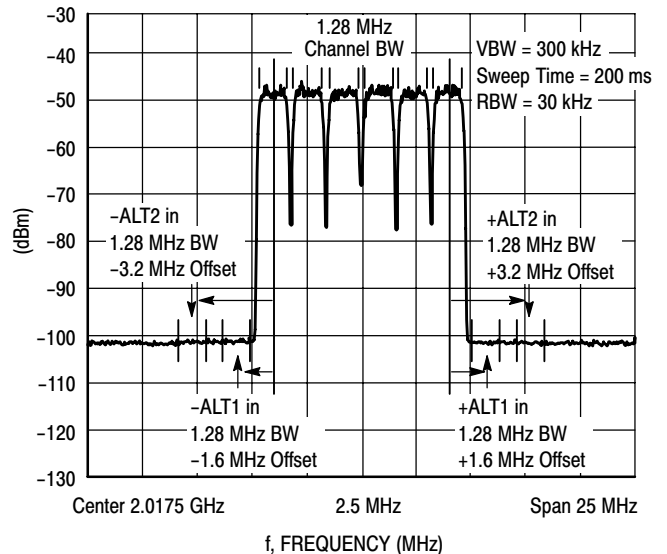
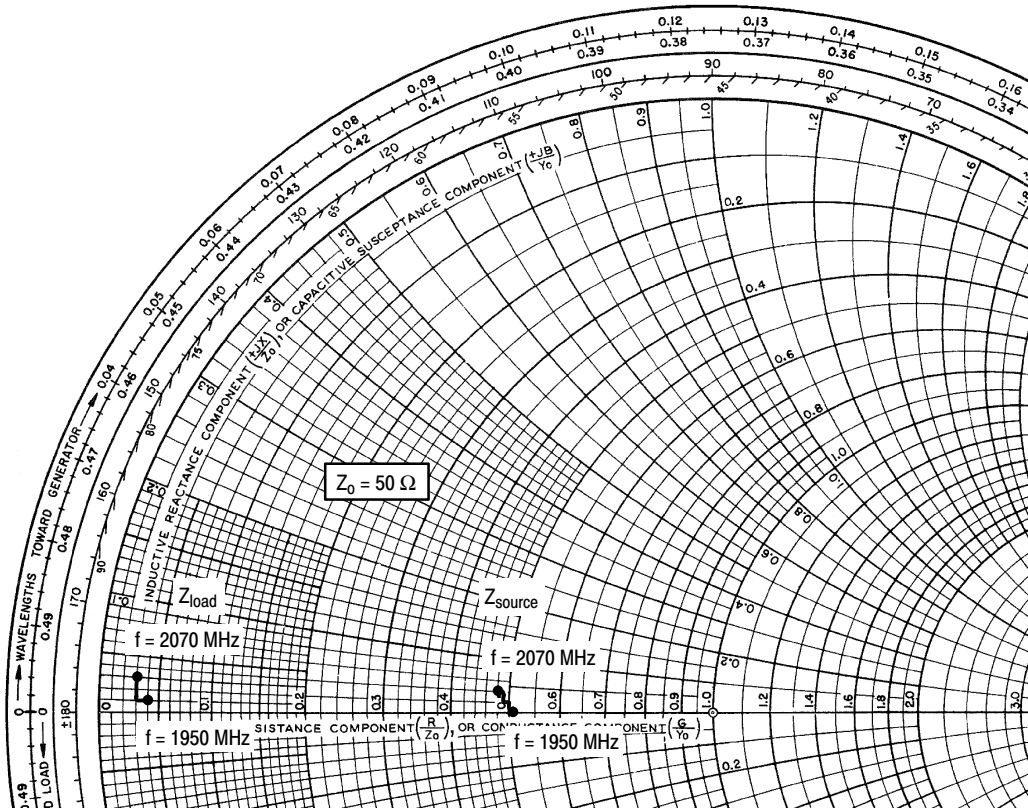

Figure 42. 6-Carrier TD-SCDMA Spectrum

MW6IC2015NBR1 MW6IC2015GNBR1



$V_{DD} = 28 \text{ Vdc}$, $I_{DQ1} = 150 \text{ mA}$, $I_{DQ2} = 160 \text{ mA}$

f MHz	Z_{source} Ω	Z_{load} Ω
1950	$25.25 + j0.19$	$1.78 + j0.33$
1960	$25.16 + j0.34$	$1.75 + j0.43$
1970	$25.07 + j0.49$	$1.72 + j0.54$
1980	$24.98 + j0.64$	$1.68 + j0.67$
1990	$24.89 + j0.79$	$1.65 + j0.78$
2000	$24.80 + j0.94$	$1.63 + j0.89$
2010	$24.71 + j1.09$	$1.62 + j1.00$
2020	$24.63 + j1.25$	$1.61 + j1.09$
2030	$24.54 + j1.40$	$1.58 + j1.19$
2040	$24.45 + j1.56$	$1.55 + j1.31$
2050	$24.37 + j1.71$	$1.50 + j1.43$
2060	$24.28 + j1.87$	$1.48 + j1.62$
2070	$24.20 + j2.03$	$1.46 + j1.65$

Z_{source} = Test circuit impedance as measured from gate to ground.

Z_{load} = Test circuit impedance as measured from drain to ground.

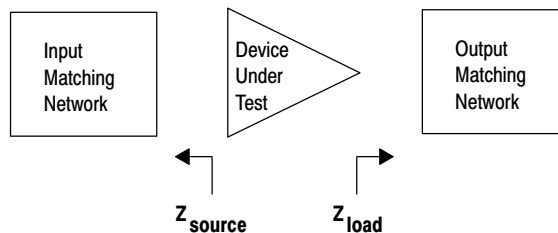
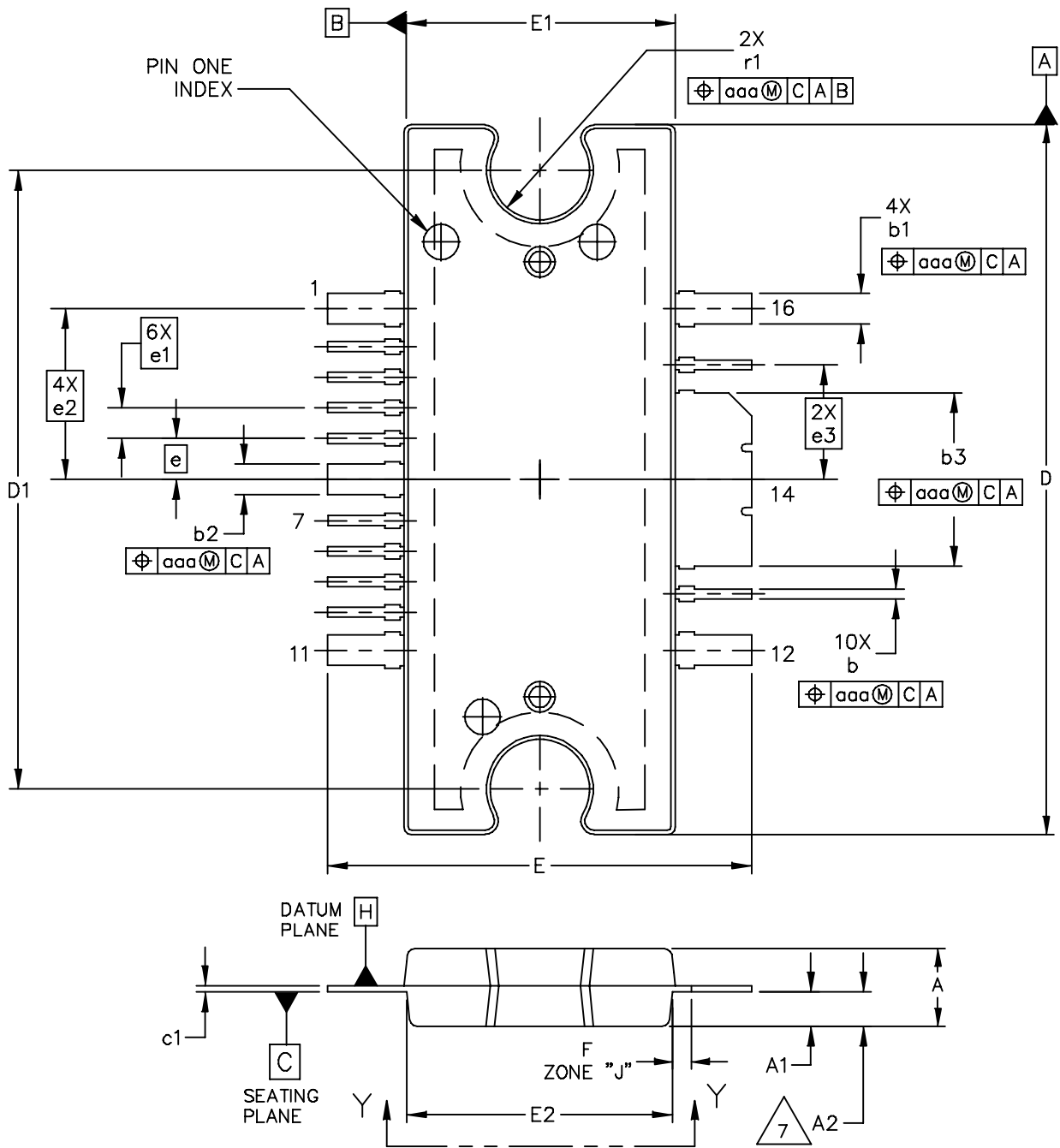

Figure 43. Series Equivalent Input and Load Impedance — TD-SCDMA

PACKAGE DIMENSIONS



© FREESCALE SEMICONDUCTOR, INC. ALL RIGHTS RESERVED.	MECHANICAL OUTLINE	PRINT VERSION NOT TO SCALE
TITLE: TO-272 WIDE BODY MULTI-LEAD	DOCUMENT NO: 98ARH99164A	REV: M
	CASE NUMBER: 1329-09	23 AUG 2007
	STANDARD: NON-JEDEC	

MW6IC2015NBR1 MW6IC2015GNBR1

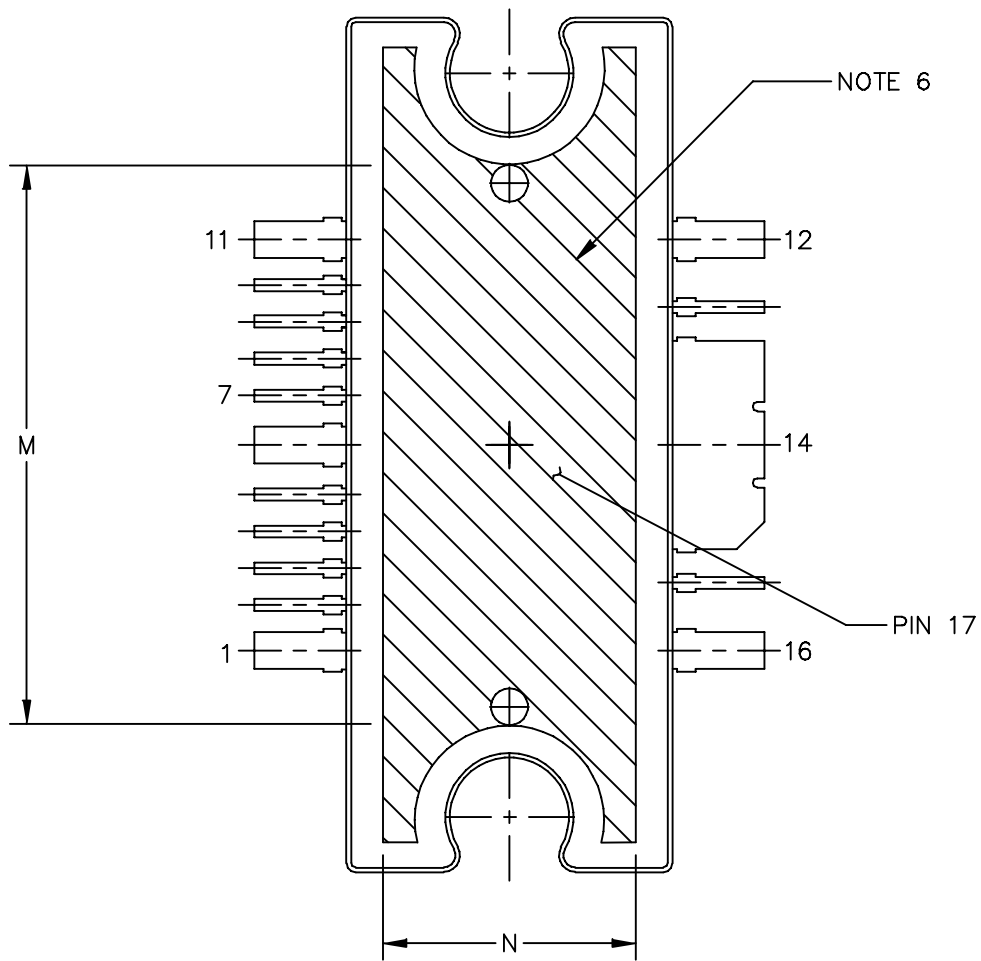

VIEW Y-Y

© FREESCALE SEMICONDUCTOR, INC. ALL RIGHTS RESERVED.	MECHANICAL OUTLINE	PRINT VERSION NOT TO SCALE	
TITLE: TO-272 WIDE BODY MULTI-LEAD	DOCUMENT NO: 98ARH99164A	REV: M	
	CASE NUMBER: 1329-09	23 AUG 2007	
	STANDARD: NON-JEDEC		

NOTES:

1. CONTROLLING DIMENSION: INCH
2. INTERPRET DIMENSIONS AND TOLERANCES PER ASME Y14.5M-1994.
3. DATUM PLANE -H- IS LOCATED AT THE TOP OF LEAD AND IS COINCIDENT WITH THE LEAD WHERE THE LEAD EXITS THE PLASTIC BODY AT THE TOP OF THE PARTING LINE.
4. DIMENSIONS "D" AND "E1" DO NOT INCLUDE MOLD PROTRUSION. ALLOWABLE PROTRUSION IS .006 (0.15) PER SIDE. DIMENSIONS "D" AND "E1" DO INCLUDE MOLD MISMATCH AND ARE DETERMINED AT DATUM PLANE -H-.
5. DIMENSIONS "b", "b1", "b2" AND "b3" DO NOT INCLUDE DAMBAR PROTRUSION. ALLOWABLE DAMBAR PROTRUSION SHALL BE .005 (0.13) TOTAL IN EXCESS OF THE "b", "b1", "b2" AND "b3" DIMENSIONS AT MAXIMUM MATERIAL CONDITION.
6. HATCHING REPRESENTS THE EXPOSED AREA OF THE HEAT SLUG. HATCHED AREA SHOWN IS ON THE SAME PLANE.
7. DIM A2 APPLIES WITHIN ZONE "J" ONLY.

DIM	INCH		MILLIMETER		DIM	INCH		MILLIMETER	
	MIN	MAX	MIN	MAX		MIN	MAX	MIN	MAX
A	.100	.104	2.54	2.64	b	.011	.017	0.28	0.43
A1	.038	.044	0.96	1.12	b1	.037	.043	0.94	1.09
A2	.040	.042	1.02	1.07	b2	.037	.043	0.94	1.09
D	.928	.932	23.57	23.67	b3	.225	.231	5.72	5.87
D1	.810 BSC		20.57 BSC		c1	.007	.011	.18	.28
E	.551	.559	14.00	14.20	e	.054 BSC		1.37 BSC	
E1	.353	.357	8.97	9.07	e1	.040 BSC		1.02 BSC	
E2	.346	.350	8.79	8.89	e2	.224 BSC		5.69 BSC	
F	.025 BSC		0.64 BSC		e3	.150 BSC		3.81 BSC	
M	.600	----	15.24	----	r1	.063	.068	1.6	1.73
N	.270	----	6.86	----	aaa	.004		.10	
© FREESCALE SEMICONDUCTOR, INC. ALL RIGHTS RESERVED.			MECHANICAL OUTLINE			PRINT VERSION NOT TO SCALE			
TITLE: TO-272 WIDE BODY MULTI-LEAD					DOCUMENT NO: 98ARH99164A			REV: M	
					CASE NUMBER: 1329-09			23 AUG 2007	
					STANDARD: NON-JEDEC				

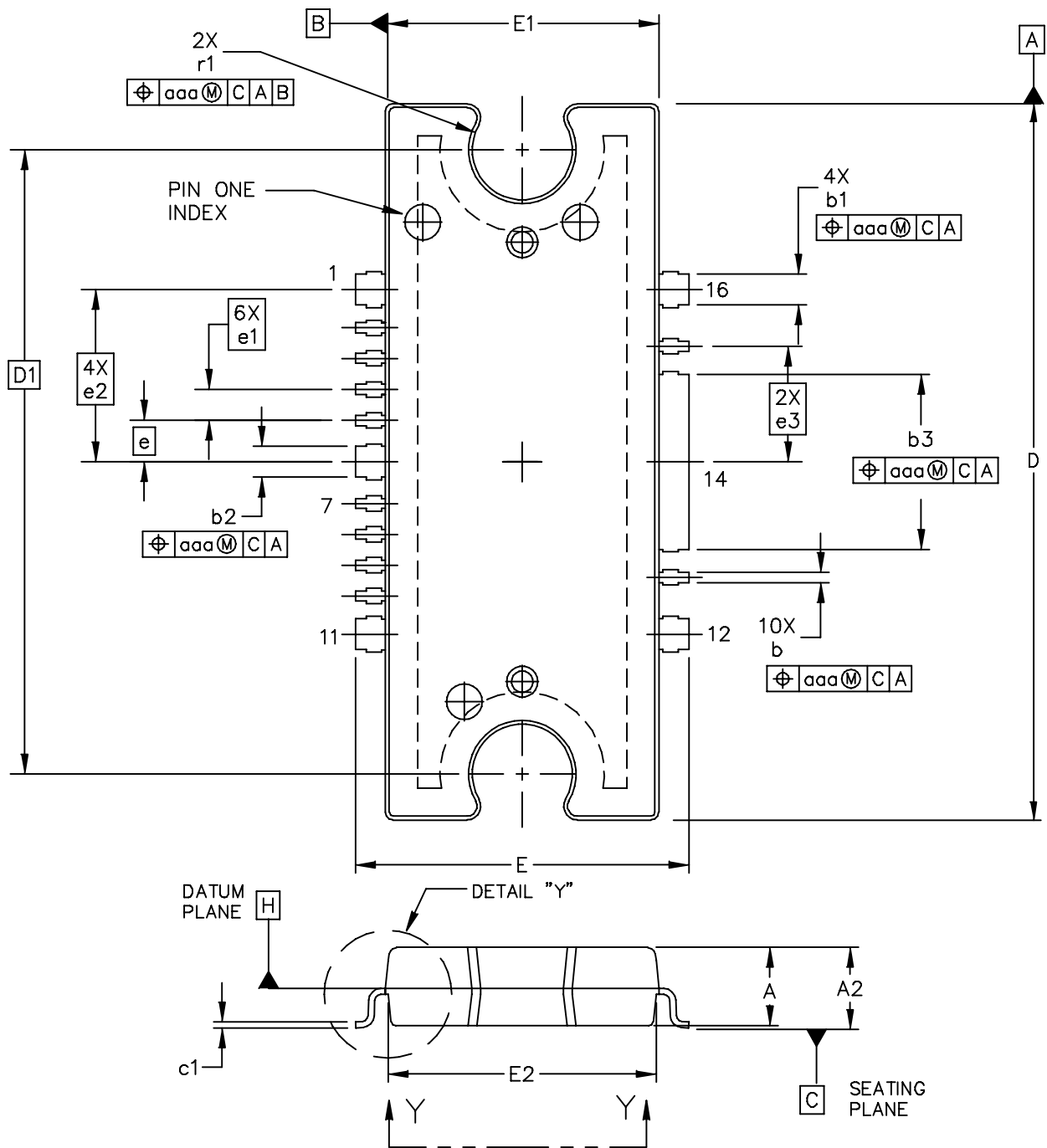

© FREESCALE SEMICONDUCTOR, INC. ALL RIGHTS RESERVED.	MECHANICAL OUTLINE	PRINT VERSION NOT TO SCALE
	TITLE: TO-272WB, 16 LEAD GULL WING PLASTIC	DOCUMENT NO: 98ASA10532D CASE NUMBER: 1329A-04 STANDARD: JEDEC MO-253 BA

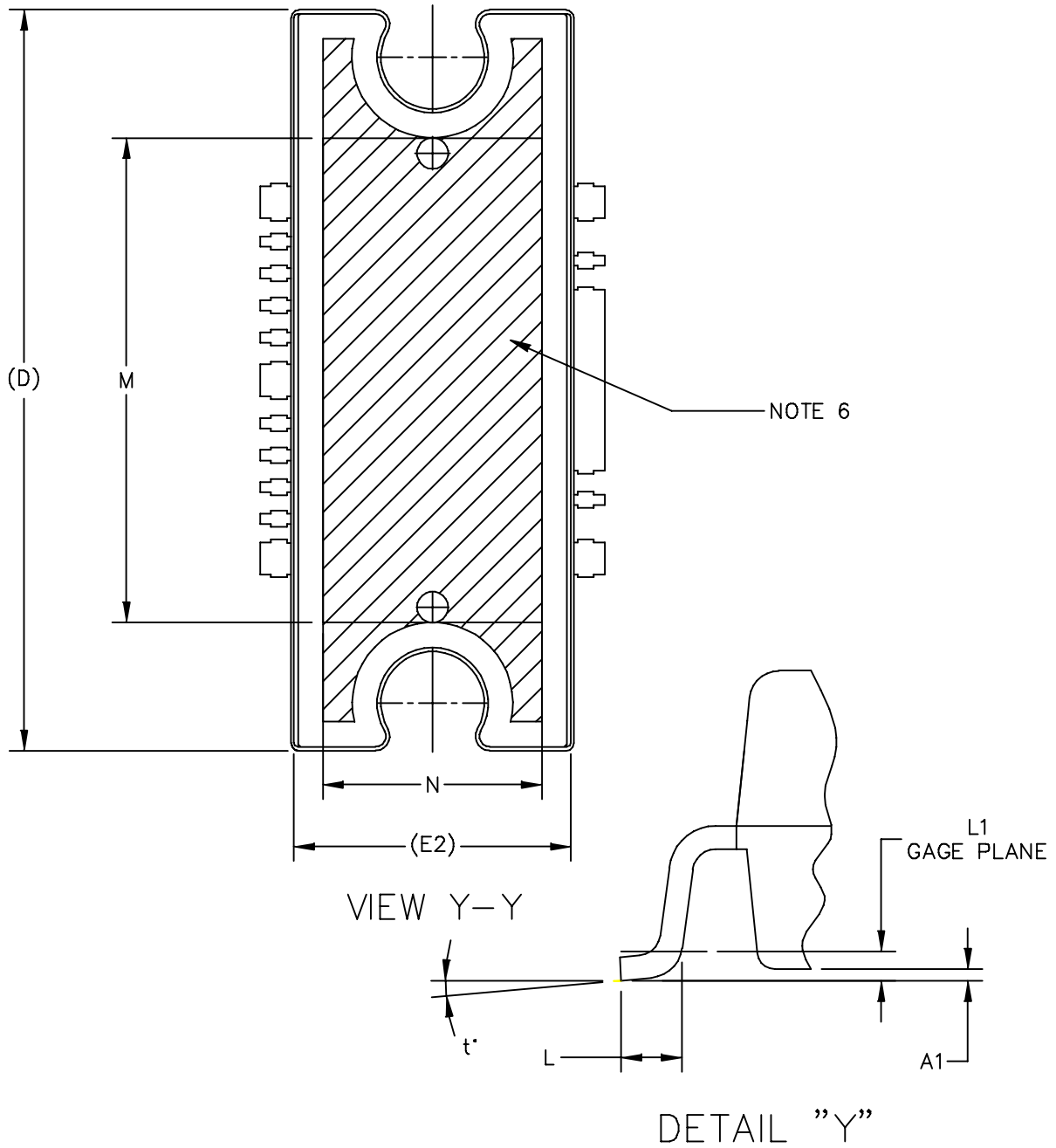

© FREESCALE SEMICONDUCTOR, INC. ALL RIGHTS RESERVED.	MECHANICAL OUTLINE	PRINT VERSION NOT TO SCALE	
TITLE: TO-272WB, 16 LEAD GULL WING PLASTIC	DOCUMENT NO: 98ASA10532D	REV: F	
	CASE NUMBER: 1329A-04	20 JUN 2007	
	STANDARD: JEDEC MO-253 BA		

MW6IC2015NBR1 MW6IC2015GNBR1

NOTES:

1. CONTROLLING DIMENSION: INCH
2. INTERPRET DIMENSIONS AND TOLERANCES PER ASME Y14.5M-1994.
3. DATUM PLANE -H- IS LOCATED AT THE TOP OF LEAD AND IS COINCIDENT WITH THE LEAD WHERE THE LEAD EXITS THE PLASTIC BODY AT THE TOP OF THE PARTING LINE.
4. DIMENSIONS "D" AND "E1" DO NOT INCLUDE MOLD PROTRUSION. ALLOWABLE PROTRUSION IS .006 (0.15) PER SIDE. DIMENSIONS "D" AND "E1" DO INCLUDE MOLD MISMATCH AND ARE DETERMINED AT DATUM PLANE -H-.
5. DIMENSIONS "b", "b1", "b2" AND "b3" DO NOT INCLUDE DAMBAR PROTRUSION. ALLOWABLE DAMBAR PROTRUSION SHALL BE .005 (0.13) TOTAL IN EXCESS OF THE "b", "b1", "b2" AND "b3" DIMENSIONS AT MAXIMUM MATERIAL CONDITION.
6. HATCHING REPRESENTS EXPOSED AREA OF THE HEAT SLUG. HATCHED AREA SHOWN IS ON THE SAME PLANE.

DIM	INCH		MILLIMETER		DIM	INCH		MILLIMETER	
	MIN	MAX	MIN	MAX		MIN	MAX	MIN	MAX
A	.100	.104	2.54	2.64	b	.011	.017	0.28	0.43
A1	.001	.004	0.02	0.10	b1	.037	.043	0.94	1.09
A2	.099	.110	2.51	2.79	b2	.037	.043	0.94	1.09
D	.928	.932	23.57	23.67	b3	.225	.231	5.72	5.87
D1	.810 BSC		20.57 BSC		c1	.007	.011	.18	.28
E	.429	.437	10.9	11.1	e	.054 BSC		1.37 BSC	
E1	.353	.357	8.97	9.07	e1	.040 BSC		1.02 BSC	
E2	.346	.350	8.79	8.89	e2	.224 BSC		5.69 BSC	
L	.018	.024	0.46	0.61	e3	.150 BSC		3.81 BSC	
L1	.01 BSC		0.25 BSC		r1	.063	.068	1.6	1.73
M	.600	----	15.24	----	t	2'	8'	2'	8'
N	.270	----	6.86	----	aaa	.004		.10	
© FREESCALE SEMICONDUCTOR, INC. ALL RIGHTS RESERVED.			MECHANICAL OUTLINE			PRINT VERSION NOT TO SCALE			
TITLE: TO-272 WB 16 LEAD GULL WING PLASTIC					DOCUMENT NO: 98ASA10532D			REV: F	
					CASE NUMBER: 1329A-04			20 JUN 2007	
					STANDARD: JEDEC MO-253 BA				

PRODUCT DOCUMENTATION

Refer to the following documents to aid your design process.

Application Notes

- AN1907: Solder Reflow Attach Method for High Power RF Devices in Plastic Packages
- AN1955: Thermal Measurement Methodology of RF Power Amplifiers
- AN1977: Quiescent Current Thermal Tracking Circuit in the RF Integrated Circuit Family
- AN1987: Quiescent Current Control for the RF Integrated Circuit Device Family
- AN3263: Bolt Down Mounting Method for High Power RF Transistors and RFICs in Over-Molded Plastic Packages

Engineering Bulletins

- EB212: Using Data Sheet Impedances for RF LDMOS Devices

REVISION HISTORY

The following table summarizes revisions to this document.

Revision	Date	Description
2	Feb. 2007	<ul style="list-style-type: none"> • Added "and TD-SCDMA" to data sheet description paragraph, p. 1. • Updated verbiage on Typical Performances table, p. 2 • Corrected V_{BIAS} and V_{SUPPLY} callouts, Figs. 3 and 21, Test Circuit Schematic, p. 4, 11, Figs. 4 and 22, Test Circuit Component Layout, p. 5, 12 • Updated Part Numbers in Tables 6 and 7, Component Designations and Values, to RoHS compliant part numbers, p. 4, 11 • Adjusted scale for Figs. 7 and 25, Two-Tone Power Gain versus Output Power, Figs. 8 and 26, Intermodulation Distortion Products versus Output Power, Figs. 11 and 29, 2-Carrier W-CDMA ACPR, IM3, Power Gain and Power Added Efficiency versus Output Power, Figs. 12 and 30, Power Gain and Power Added Efficiency versus CW Output Power, Figs. 16 and 34, EVM and Power Added Efficiency versus Output Power, Figs. 17 and 35, Spectral Regrowth at 400 and 600 kHz versus Output Power, to better match the device's capabilities, p. 6-8, 13-15 • Replaced Figure 18, MTTF versus Junction Temperature with updated graph. Removed Amps² and listed operating characteristics and location of MTTF calculator for device, p. 9 • Corrected Series Impedance data table test conditions, Figs. 20 and 36, p. 10, 16 • Added TD-SCDMA test circuit schematic, component designations and values, component layout, typical characteristic curves, test signal and series impedance, p. 17-20. • Added Product Documentation and Revision History, p. 27
3	Dec. 2008	<ul style="list-style-type: none"> • Modified data sheet to reflect RF Test Reduction described in Product and Process Change Notification number, PCN13232, p. 1, 2 • Changed 220°C to 225°C in Capable Plastic Package bullet, p. 1 • Added Footnote 1 to Quiescent Current Temperature bullet under Features section and to callout in Fig. 1, Functional Block Diagram, p. 1 • Changed Storage Temperature Range in Max Ratings table from -65 to +200 to -65 to +150 for standardization across products, p. 2 • Added Case Operating Temperature limit to the Maximum Ratings table and set limit to 150°C, p. 2 • Operating Junction Temperature increased from 200°C to 225°C in Maximum Ratings table and related "Continuous use at maximum temperature will affect MTTF" footnote added, p. 2 • Updated Part Numbers in Tables 6, 7, and 8 Component Designations and Values, to latest RoHS compliant part numbers, p. 4, 11, 17 • Removed lower voltage tests from Figs. 13 and 31, Power Gain versus Output Power, due to fixed tuned fixture limitations, p. 7, 14 • Adjust scale for Fig. 27, Intermodulation Distortion Products versus Tone Spacing, to show wider dynamic range, p. 14 • Replaced Case Outline 1329A-03 with 1329A-04, Issue F, p. 1, 24-26. Added pin numbers 1 through 17. Corrected mm dimension L for gull-wing foot from 4.90-5.06 Min-Max to 0.46-0.61 Min-Max. Corrected L1 mm dimension from .025 BSC to 0.25 BSC. Added JEDEC Standard Package Number. • Replaced Case Outline 1329-09, Issue L, with 1329-09, Issue M, p. 21-23. Added pin numbers 1 through 17.

How to Reach Us:

Home Page:

www.freescale.com

Web Support:

<http://www.freescale.com/support>

USA/Europe or Locations Not Listed:

Freescale Semiconductor, Inc.
Technical Information Center, EL516
2100 East Elliot Road
Tempe, Arizona 85284
1-800-521-6274 or +1-480-768-2130
www.freescale.com/support

Europe, Middle East, and Africa:

Freescale Halbleiter Deutschland GmbH
Technical Information Center
Schatzbogen 7
81829 Muenchen, Germany
+44 1296 380 456 (English)
+46 8 52200080 (English)
+49 89 92103 559 (German)
+33 1 69 35 48 48 (French)
www.freescale.com/support

Japan:

Freescale Semiconductor Japan Ltd.
Headquarters
ARCO Tower 15F
1-8-1, Shimo-Meguro, Meguro-ku,
Tokyo 153-0064
Japan
0120 191014 or +81 3 5437 9125
support.japan@freescale.com

Asia/Pacific:

Freescale Semiconductor China Ltd.
Exchange Building 23F
No. 118 Jianguo Road
Chaoyang District
Beijing 100022
China
+86 10 5879 8000
support.asia@freescale.com

For Literature Requests Only:

Freescale Semiconductor Literature Distribution Center
P.O. Box 5405
Denver, Colorado 80217
1-800-441-2447 or +1-303-675-2140
Fax: +1-303-675-2150
LDCForFreescaleSemiconductor@hibbertgroup.com

Information in this document is provided solely to enable system and software implementers to use Freescale Semiconductor products. There are no express or implied copyright licenses granted hereunder to design or fabricate any integrated circuits or integrated circuits based on the information in this document.

Freescale Semiconductor reserves the right to make changes without further notice to any products herein. Freescale Semiconductor makes no warranty, representation or guarantee regarding the suitability of its products for any particular purpose, nor does Freescale Semiconductor assume any liability arising out of the application or use of any product or circuit, and specifically disclaims any and all liability, including without limitation consequential or incidental damages. "Typical" parameters that may be provided in Freescale Semiconductor data sheets and/or specifications can and do vary in different applications and actual performance may vary over time. All operating parameters, including "Typicals", must be validated for each customer application by customer's technical experts. Freescale Semiconductor does not convey any license under its patent rights nor the rights of others. Freescale Semiconductor products are not designed, intended, or authorized for use as components in systems intended for surgical implant into the body, or other applications intended to support or sustain life, or for any other application in which the failure of the Freescale Semiconductor product could create a situation where personal injury or death may occur. Should Buyer purchase or use Freescale Semiconductor products for any such unintended or unauthorized application, Buyer shall indemnify and hold Freescale Semiconductor and its officers, employees, subsidiaries, affiliates, and distributors harmless against all claims, costs, damages, and expenses, and reasonable attorney fees arising out of, directly or indirectly, any claim of personal injury or death associated with such unintended or unauthorized use, even if such claim alleges that Freescale Semiconductor was negligent regarding the design or manufacture of the part.

Freescale™ and the Freescale logo are trademarks of Freescale Semiconductor, Inc. All other product or service names are the property of their respective owners.

© Freescale Semiconductor, Inc. 2006-2008. All rights reserved.

